

Engineered for laboratory drainage

Technical Data
& Dimensions

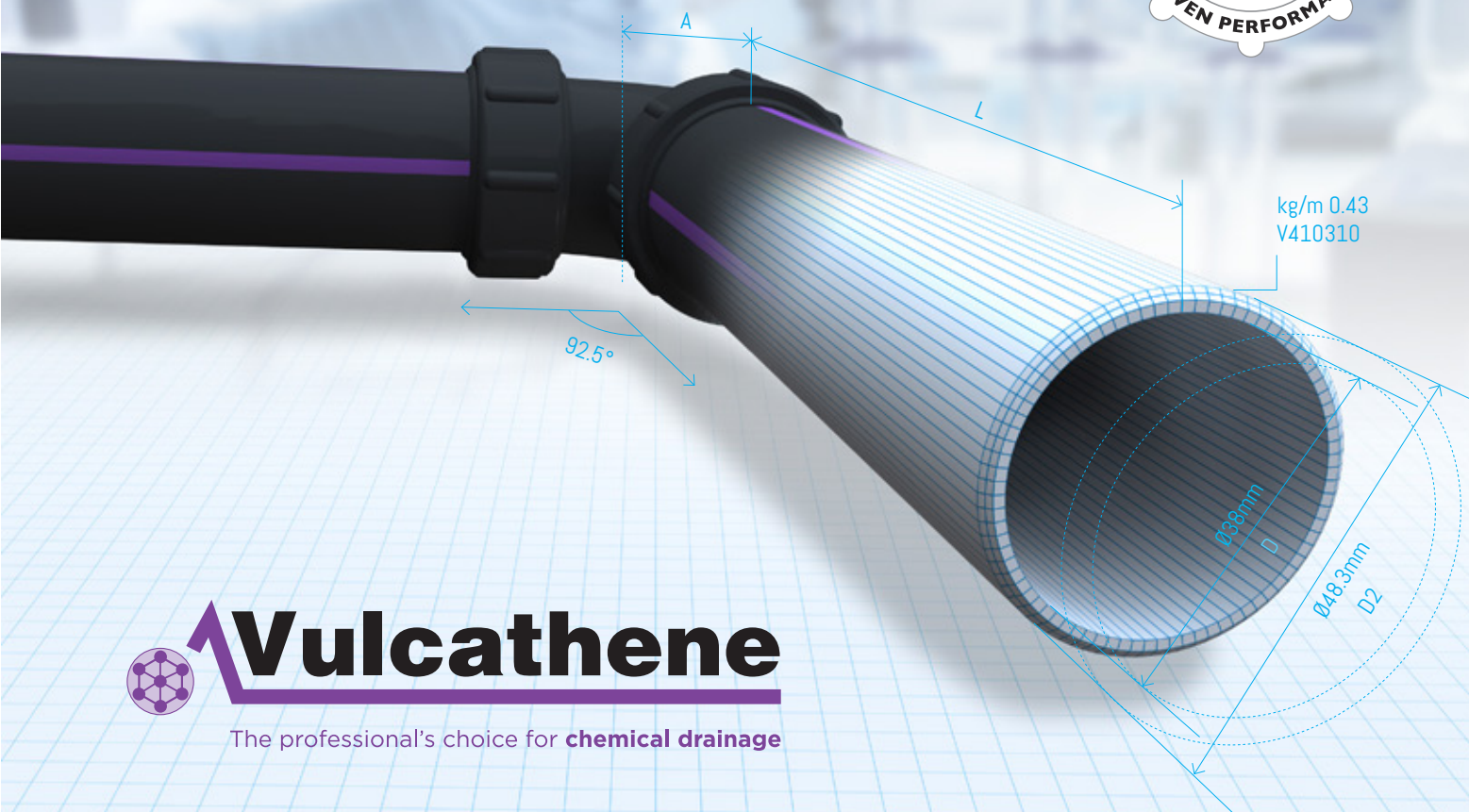

 **Vulcathene**

The professional's choice for **chemical drainage**



Purpose designed for safe chemical drainage

Specified worldwide and proven as the world leading solution for chemical waste drainage



- Two easy jointing methods
Mechanical or Enfusion
- Injection moulded fittings for
accuracy and reliability
- Purpose designed for
chemical drainage
- BBA tested/approved for
chemical drainage
- Specified world wide for
safe chemical drainage



Specified worldwide for laboratory drainage for over 65 years

Vulcathene boasts over 65 years proven performance in the laboratories of thousands of schools, universities, hospitals and research facilities around the world... proof of its very high reliability for safe chemical drainage.



Contents

System Overview (Enfusion & Mechanical)	4
Standards & Quality	5
The System	6-7
Material Properties	8
Product Range Overview	
<i>Pipe, Bench Products and Ancillaries</i>	9
<i>Mechanical Fittings</i>	10
<i>Enfusion Fittings</i>	11
Pipe, Bench Products and Ancillaries	
<i>Vulcathene Pipe</i>	12
<i>Waste Outlets / Standing Wastes</i>	12
<i>Plugs / Overflow Assemblies</i>	13
<i>Drip Cups</i>	13-14
<i>Sinks</i>	14-15
<i>Troughs / Traps</i>	15-18
<i>Accessories</i>	18-20
<i>Flexible Couplings</i>	21
Mechanical Fittings	
<i>Bends</i>	22
<i>Tees / Wyes</i>	23
<i>Corner Branches / U Bends / Couplers</i>	24-25
<i>Reducers / Adaptors / Sight Glass</i>	26
<i>Thermal Stress Relief Units</i>	26-27
<i>Access Pipes / Flanges</i>	27
<i>Olives / Nuts / Blanking Off Plugs / Groove Cutting Tool / Spanner</i>	28
Polyfusion Adaptors	29
Mechanical Drainage Design	30
Making the Mechanical Joint	31-32
Enfusion Fittings	
<i>Bends</i>	33-34
<i>Tees / Wyes / Branches</i>	35-36
<i>Tubular Traps</i>	37
<i>Couplers / Adaptors</i>	37-38
<i>Thermal Stress Relief Units</i>	39
<i>Access Pipes</i>	39
<i>Flanges</i>	40
<i>Cleanout Plugs</i>	40
<i>Vulcathene Enfusion Tools</i>	41
Enfusion Drainage System	41
Making the Enfusion Joint	42-44
Vulcathene Installation Advice	44-47
UniCollar® Fire Protection	48-49
Connection to other Pipework	50-52
Vulcathene Chemical Resistance Data	53-64
Durapipe UK Pipework Systems	65

Two easy jointing methods...



Vulcathene Enfusion System Overview

Under normal laboratory conditions the Vulcathene Mechanical drainage system is more than sufficient. Where a fused joint is preferred - for example, where pipe is to be buried or run overhead in ceiling voids or in drainage stacks - the Vulcathene Enfusion electrofusion range of chemical waste fittings is recommended.

Vulcathene Enfusion fitting sockets are moulded with an integral resistance wire in place. Jointing is completed by energizing the resistance wire via a microprocessor controlled Enfusion Control Unit.

Vulcathene Enfusion is compatible with Vulcathene Mechanical offering total versatility to the designer of chemical waste drainage systems.

- Design flexibility
- Easy to install
- Multiple jointing
- Controlled fusion
- Voltage sensing
- Fusion time adjustment
- Self-diagnostic unit



Enfusion has proven over time that it produces the optimum level of performance where it matters most - at the joint interface. It offers unprecedented control of jointing - controlled fit, controlled temperature and controlled time.

Vulcathene Mechanical System Overview

The Vulcathene Mechanical system is a complete purpose-designed chemical resistant plumbing system which embraces laboratory bench items such as wastes, sinks and drip cups, anti-siphon traps, expansion joints plus a comprehensive range of pipe fittings from 38mm to 102mm. Mechanical Jointing, with its unique nut & olive method, is simple & fast to execute and joints can be easily made and remade without affecting the joint's efficiency, allowing system changes to be made at reduced cost. Simple, purpose designed tools ensure correct installation.

- Purpose designed and engineered system
- Simple, fast jointing method
- Demountable joints
- Anti-siphon traps
- Borosilicate glass base traps
- British Board of Agrément approved
- Co-polymer based material
High chemical resistance rating; abrasion resistant; high impact strength; weather resistant; wide temperature capability
- Unsurpassed record of success in drainage applications



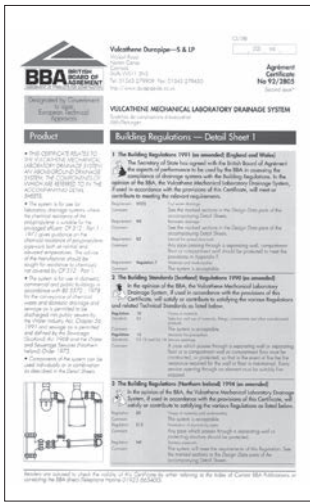

Standards & Quality

Vulcathene products are manufactured in accordance with BS EN ISO 9001. Products are subjected to a range of checks and tests. Detailed records are kept for dimensional and performance tests for each production batch. Each batch is given a unique identification number, which is reproduced on every fitting giving complete traceability.

Vulcathene pipes and fittings are manufactured within an environmental management system which operates in accordance with the requirements of ISO 14001. Whilst there is no specific British or CEN Standard for the performance of a chemical waste drainage system, the products manufactured for the Vulcathene system are covered by Agrément Certificates which ensures their fitness for purpose.



British Board of Agrément Specification Clauses

Material and Manufacture

Manufactured from co-polymer polypropylene with 3% carbon black ultra violet stabiliser. All fittings injection moulded from virgin grade polypropylene. All pipes to be extruded from virgin grade polypropylene.

Mechanical System

All mechanical joints to be demountable compression. All joints incorporate a positive seal utilising a 'tongued' olive located in a groove cut into the external wall on the pipe. This combines system security with the ability to disassemble the system if required.

Traps

All traps should be of the anti-siphonic type, preventing suction developing within the system which could prevent effective drainage of chemicals. Vulcathene traps with a Borosilicate glass base must be used with particularly strong chemical solutions and when large amounts of organic solvents are used.

Where the W691 Dilution Recovery Trap is used, the underside of the trap must be supported to prevent undue strain on the pipework system.



Chemical Resistance
 For chemical resistance data see pages 53-64.

If in any doubt about the action of any chemicals on Vulcathene, or there is the possibility that any of the products in this manual are to be used in situations where specialised or unusual chemicals are involved, please contact our Technical Support Department on +44 (0)1543 471681.

CAD & BIM
 CAD drawings and BIM models for the Vulcathene chemical drainage system are available for download from www.durapipe.co.uk/technical-support.

The System

Vulcathene is a proven chemical resistant pipework system installed in laboratories in schools, universities, hospitals and industrial facilities worldwide over a 60 year period. Vulcathene is proven with all chemical combinations emptied into it including acids, alkalis, solvents, detergents, blood samples, retro viruses and radioactive wastes.

Vulcathene is a complete laboratory system including waste outlets, sinks, drip cups, anti-siphon traps, dilution recovery traps and a comprehensive range of pipe and fittings in sizes 38mm to 152mm.

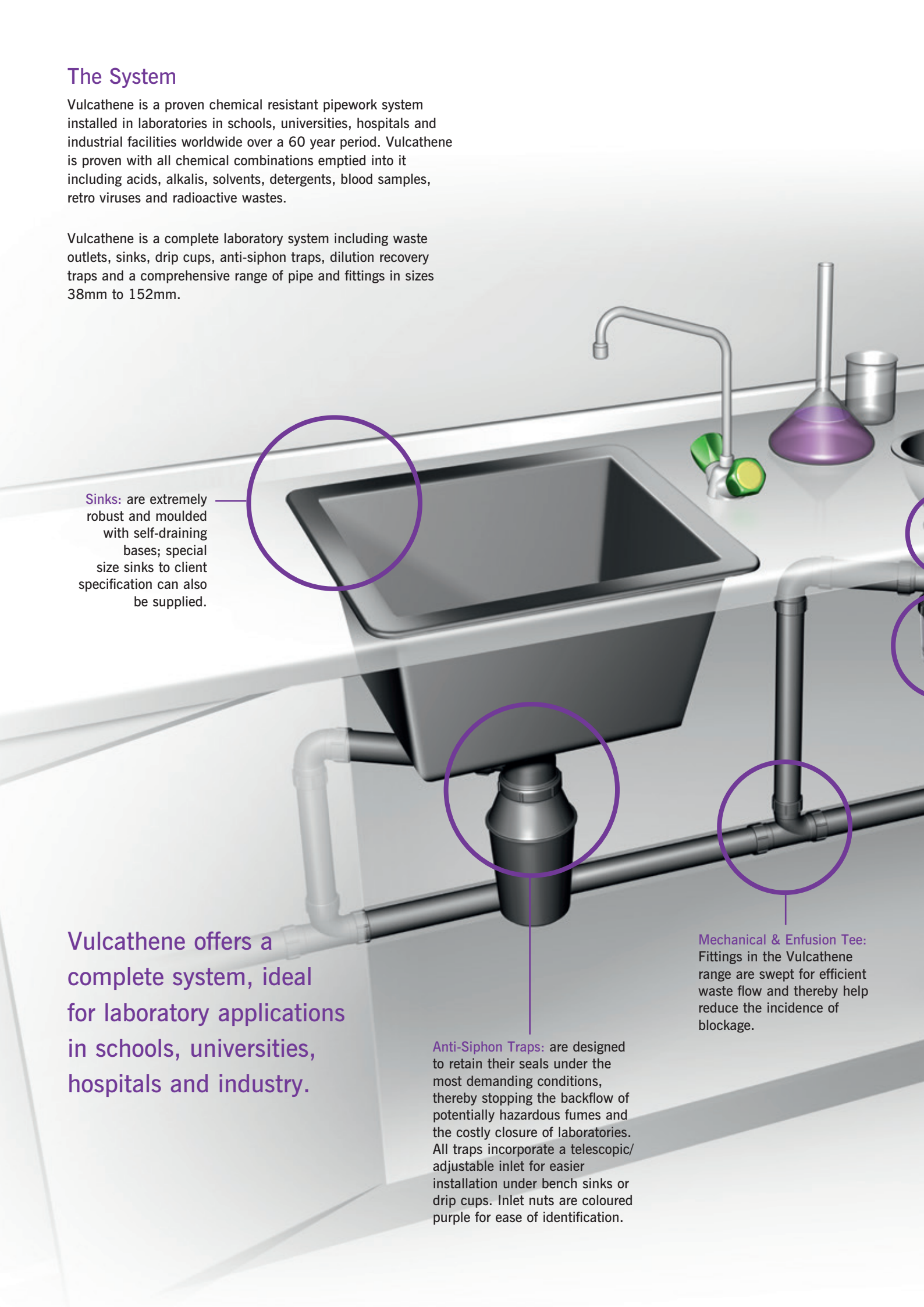

Sinks: are extremely robust and moulded with self-draining bases; special size sinks to client specification can also be supplied.

Vulcathene offers a complete system, ideal for laboratory applications in schools, universities, hospitals and industry.

Anti-Siphon Traps: are designed to retain their seals under the most demanding conditions, thereby stopping the backflow of potentially hazardous fumes and the costly closure of laboratories. All traps incorporate a telescopic/adjustable inlet for easier installation under bench sinks or drip cups. Inlet nuts are coloured purple for ease of identification.

Mechanical & Enfusion Tee: Fittings in the Vulcathene range are swept for efficient waste flow and thereby help reduce the incidence of blockage.

Vulcathene - over 65 years of quality...



- Manufacturing: Quality is central to the operation with BS EN ISO 9001 certification and within an environmental management system which operates in accordance with the requirements of ISO 14001.



- Technical support: We offer an unrivalled level of technical support where our experienced team can provide product training and installation advice on any given project. They also provide material take-off advice from architects drawings.

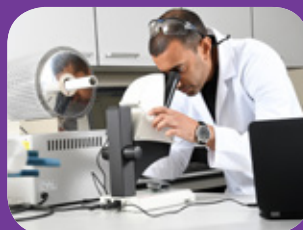

- Laboratory testing: Expert advice about the action of any chemicals on Vulcathene is available from the Vulcathene chemist.

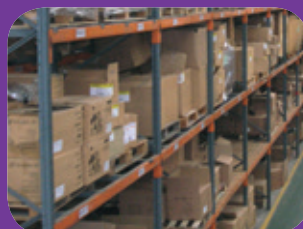

- Warehouse & Stock Control: Using computerised stock control a significant level of Vulcathene stock is maintained. We operate through a nationwide distribution network providing swift and local availability of product.



- On site support: Our external sales team are trained in the products and their usage and provide a service to the customer with advice, assistance, training and problem solving on site.



- Customer satisfaction: Vulcathene boasts over 65 years proven performance in the laboratories of thousands of schools, universities, hospitals and research facilities around the world... proof of its very high reliability for safe chemical drainage.

Drip cups: have steep sloping sides to minimise splashing and wide rims for stability when mounting. Oval drip cups offer the flexibility of alternative flange fixings. Alternative colours can also be supplied.

Unique Tapered Sealing: Vulcathene waste outlets, drip cups and traps incorporate a unique taper providing a perfect seal when used together.

Borosilicate Glass Base Traps: can cope with particularly strong chemical solutions and organic solvents. Also allows for visible identification and recovery of valuable solids.

Vulcathene Material Properties

Manufactured from co-polymer polypropylene with 3% carbon black ultra-violet stabiliser. Vulcathene has very high resistance to chemical attack and is well suited to the conveyance of aggressive chemicals, and other liquids as used in chemical plants and laboratory waste.

The performance specification is based on the need to supply a waste system which has a high chemical resistance rating in respect of the corrosive materials which it has to convey. Good tensile strength, ductility, abrasion resistance, high impact strength, weather resistance, and is stable over the range of temperatures normally encountered in the environment in which it is used.

Vulcathene is resistant to many concentrated acids and alkalis and some organic solvents. Vulcathene also has a good abrasion resistance throughout its operational temperature range of between -20°C and +100°C.

With a smooth bore, it is lightweight with a specific gravity of 0.905. It has high impact strength, which minimises damage during and after installation.

The full specification to which Vulcathene pipe and fittings are manufactured is detailed below.

Property	Test Method	Unit		
Melt flow index (MFI)	230°C/2.16 kg	Granules	6.5	
Density (mean)		kg/m ³	9.5	
Tensile yield stress	ISO 527 ASTM D 638M (50mm/min)	MPa kg/cm ²	27.0 295	
Flexural modulus	ISO 178 ASTM D 790	GPa kg/cm ²	1.15 14100	
Izod impact strength	ISO 180 (0.25mm notch radius)	kJ/m ²	23°C 7.0 0°C 4.5 -20°C 3.0 -40°C -	
Rockwell hardness	ISO 2039/2, ASTM D 785		R scale	90
Vicat softening temperature (10 N force)	ISO 306A BS 2782; 102 A		°C	147
Heat distortion temperature A - 1.8 MPa (18.6kg/cm ²) B - 0.45 MPa (4.6kg/cm ²)	ISO 75/A and /B ASTM D 648-A-B		°C °C	55 90
Flammability	ISO 3795 FMVSS 302 (2mm thickness)	Burning rate mm/min	38	

Pipe



W001 (p12)
Vulcathene Pipe

Bench Products



504 (p12)
Waste



507 (p12)
Standing Waste Tube



508 (p13)
Plug & Chain Assembly



509 (p13)
Overflow Assembly



501 (p13)
Small Circular Drip Cup



500 (p13)
Large Circular Drip Cup



497 (p14)
Small Oval Drip Cup



499B (p14)
Large Oval Drip Cup



499T (p14)
Large Oval Drip Cup



601 (p14)
Sink



602 (p14)
Sink



603 (p15)
Running Trough



W681 (p15)
Dilution Recovery Trap



W691 (p16)
Dilution Recovery Trap (Glass Base)



W561 (p16)
Anti-Siphon Bottle Trap



W571 (p17)
Anti-Siphon Bottle Trap (Glass Base)



W612 (p17)
Dilution Recovery Trap



910G (p17)
Dilution Recovery Trap (Glass Base)



W915 (p18)
Clay Trap

Ancillaries



(p18)
Trapped Floor Gully



PC91 (p18)
Pipe Clip



W916 (p19)
Flexible Connector



W465 (p19)
Clamp Saddle



W450 (p19)
Air Admittance Valve



W50 (p20)
Anti-Siphon Unit

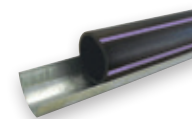

(p20)
Galvanised Support Channel



W641/W642 (p20)
Horizontal Inlet



(p20)
Vulcathene Lubricant



(p20)
Glass Dip Tube



W651/W652 (p20)
Vertical Inlet



(p20)
Blanking Off Plug



(p20)
UniCollar® Fire Protection



DC95/DC115 (p21)
Flexible Drain Coupling



AC1221/AC1361
AC5144/AC1362 (p21)
Flexible Adaptor Coupling



W18 (p22)
92¹/₂° Bend



W29 (p22)
92¹/₂° Loose Nut
Sweep Bend



W19 (p22)
135° Slow Bend



W21 (p22)
135° Loose Nut
Slow Bend



W20 (p23)
92¹/₂° Equal
Sweep Tee



W20 (p23)
92¹/₂° Reducing
Sweep Tee



W37 (p23)
45° Single Wye



W38 (p23)
45° Double Wye



W942 (p24)
90° Corner Branch



W70 (p24)
'U' Bend



W16 (p24)
Line Coupler



W39 (p25)
Reducing Coupler



W14 (p25)
M.I. to Pipe Coupler



W15 (p25)
F.I. to Pipe Coupler



W271 (p25)
1³/₄" F.I. to Pipe Coupler



W121 (p26)
1¹/₄" F.I. to 1¹/₂" M.I. BSP
Reducer



W45 (p26)
Glass Adaptor



W801 (p26)
Thermal Stress Relief Unit



W802 (p27)
Thermal Stress Relief Unit



W803/W804 (p27)
Thermal Stress Relief Unit



W902/W903/W904 (p27)
Access Pipes



W100 (p27)
BS Table D Flange



W22 (p28)
Olive



W23 (p28)
Nut



W24 (p28)
Blanking-Off Plug



W26 (p28)
Groove Cutting Tool



W36 (p28)
Spanner

Polyfusion Adaptors



C130 (p29)
Half Coupler



P758 (p29)
BSP Coupler



200 (p29)
Hand Tool



L28 (p33)
Single Socket Long Sweep Bend



L29 (p33)
Single Socket Short Sweep Bend



L291A (p33)
Loose Nut/Socket Short Sweep Bend



L17 (p34)
Double Socket Long Sweep Bend



L18 (p34)
Double Socket Short Sweep Bend



L19 (p34)
45° Double Socket Slow Bend



L21 (p34)
45° Single Socket Slow Bend



L20 (p35)
92¹/₂° Equal Sweep Tee



L20 (p35)
92¹/₂° Reducing Sweep Tee



L37 (p35)
45° Single Wye



L37 (p35)
45° Reducing Wye



L35 (p36)
92¹/₂° Double Branch



L942 (p36)
90° Corner Branch



L101 (p37)
U Bend



L16 (p37)
Coupling



L16 (S) (p37)
Slip Coupling



L39 (p38)
Reducing Coupler



L14 (p38)
M.I to Pipe Coupler



L15 (p38)
F.I to Pipe Coupler



L45 (p38)
Glass Adaptor



L801 (p39)
Thermal Stress Relief Unit



L802 (p39)
Thermal Stress Relief Unit



L803/4/6 (p39)
Thermal Stress Relief Unit



L902/3/4 (p39)
Access Pipe



L40 (p40)
Flange



L24 (p40)
Cleanout Plug



L2610 (p41)
Link Cable



L261 (p41)
Clamp



L2601 (p41)
Enfusion Hand-held Unit



Pipe Scraper (p41)

W001 Pipe

Produced in nominal internal diameters of 38mm, 51mm, 76mm, 102mm and 152mm (Enfusion only), Vulcathene pipes are supplied in standard 4m lengths.

	1½"	2"	3"	4"	6"
Nominal internal diameter	38mm	51mm	76mm	102mm	152mm
Nominal external diameter	48.3mm	60.3mm	89.0mm	114.3mm	168.3mm
Kg/m	0.43	0.58	1.25	1.63	4.34
Product Code	V410310	V410320	V410330	V410340	V410360

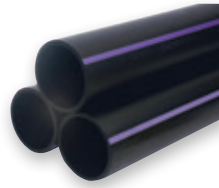

504 Waste

The range of 1¼", 1½", and 2" BSP threaded wastes are produced with flange widths of 60, 73 and 85mm to suit ceramic, porcelain, metal or plastic sink outlets. Slotted wastes are available for use where the waste has to accept an overflow. With an integral grating the waste is supplied with a plug ready to accept a chain fastening. Both the 1¼" and 1½" waste outlets are available in all flange diameters and either 89mm or 102mm lengths; the 2" waste outlet is available in 85mm flange diameter and 102mm length only. Unslotted waste outlets are supplied with one waste gasket; slotted wastes are supplied with two waste gaskets. When ordering please indicate

a. Waste diameter; b. Flange diameter; c. Whether slotted or unslotted required.

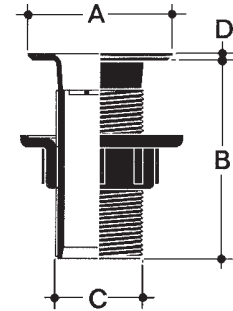

Product Code	A (mm)	B (mm)	C (inch)	D (mm)
Unslotted Waste				
V5504011	60	89	1¼	3
V5504031	73	89	1¼	3
V5504051	85	89	1¼	3
V5504071	60	102	1½	3
V5504091	73	102	1½	3
V5504111	85	102	1½	3
V5504131	85	102	2	3

gms 1¼"-65; 1½"-75; 2"-90

Product Code	A (mm)	B (mm)	C (inch)	D (mm)
Slotted Waste				
V5504021	60	89	1¼	3
V5504041	73	89	1¼	3
V5504061	85	89	1¼	3
V5504081	60	102	1½	3
V5504101	73	102	1½	3
V5504121	85	102	1½	3
V5504141	85	102	2	3

gms 1¼"-65; 1½"-75; 2"-90

507 Standing Waste Tube

Standing waste tubes are available in three lengths and the diameters are in relation to the need to fit 1¼", 1½", and 2" BSP threaded 504 series wastes. If required they can be supplied with a hanging loop. 51mm size supplied in 225mm length only. 32mm and 38mm supplied in 140mm and 178mm lengths only.

Product code	A (mm)	B (mm)
V5507011	140	32
V5507031	178	32
V5507051	140	38
V5507071	178	38
V5507091	225	51

Product code	A (mm)	B (mm)
Fitted with hanging loop		
V5507021	140	32
V5507041	178	32
V5507061	140	38
V5507081	178	38
V5507101	225	51



508 Plug & Chain Assembly

Comprising a 450mm length of stainless steel oval link chain, with a screw stay, the plug and chain assembly is available to fit either 1¼", 1½", or 2" BSP No. 504 series waste fittings.

Product code	Size (inch)
V5508501	1¼
V5508101	1½
V5508201	2

gms 1¼"-40; 1½"-44; 2"-50



509 Overflow Assembly

The range of 509 overflow assemblies are suitable for installation with a 38mm slotted waste and any sink illustrated in this catalogue. They comprise of an overflow collar connected by a flexible hose to the overflow bend. Because of the varying requirements for placement of the overflow in the side of the sink we recommend that a hole of 42mm diameter be cut in the side of the sink to take the overflow bend. The overflow is extendable from 9" to 22".

Cat. No.	509
A	60mm
B	48mm
gms	65
Product Code	V5509001

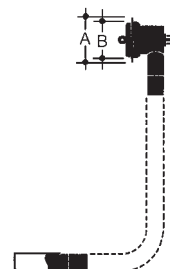

501 Small Circular Drip Cup

The range of 501 small circular drip cups, come with an integral grating and a wall thickness of 3mm. The small circular drip cup has steeply sloping sides to minimise splashing and the 8mm wide rim gives it stability when top mounted in the working surface. With an opening diameter of 86mm and depth of 73mm it is supplied complete with hose restraining plug and backnut.

Cat. No.	501
A	102mm
B	136mm
C	1½" BSP
E	5mm
F	6mm
G	76mm
Product Code	V5501001

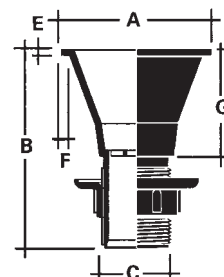

500 Large Circular Drip Cup

The range of 500 large circular drip cups come with an integral grating and a wall thickness of 3mm. The large circular drip cup is designed for top mounting. With a top opening diameter of 146mm it is 114mm deep and the 11mm wide rim gives it stability when top mounted in the working surface. It is supplied complete with a backnut and hose restraining plug.

Cat. No.	500
A	168mm
B	165mm
C	1½" BSP
E	8mm
F	11mm
G	114mm
Product Code	V5500001

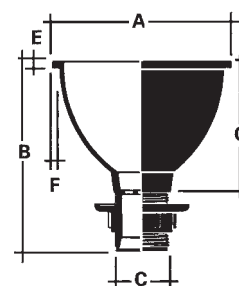

497 Small Oval Drip Cup

The range of 497 small oval drip cups are moulded with a 3mm thick wall and have an opening of 166mm x 90mm x 143mm deep. The 6mm wide rim gives it stability when top mounted in the working surface. It has an integral grating, is designed for top mounting and is supplied complete with backnut.

Cat. No.	497
A	178mm
B	216mm
C	1 1/2" BSP
D	102mm
E	6mm
F	6mm
G	143mm
Product Code	V5497001

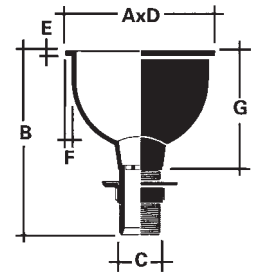

A = length D = width

499B/499T Large Oval Drip Cup

The range of 499 Large Oval Drip Cups are moulded with a 3mm thick wall, offering a choice of 2 alternative flange fixings. Moulded with deeply curved bowls, they have integral gratings and are supplied complete with backnuts and a hose restraining plug. The 499B and 499T are designed for top mounting.

Cat. No.	499B	499T
A	264mm	305mm
B	225mm	225mm
C	1 1/2" BSP	1 1/2" BSP
D	111mm	152mm
E	6mm	6mm
F	13mm	32mm
G	161mm	161mm
Product Code	V5499001	V5490001

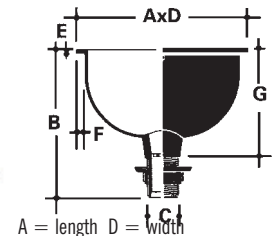

A = length D = width

601 Sink

The 601 sink is extremely robust and has a self-draining base. Its recessed outlet will accept the flange of the 1 1/2" BSP 504 non-overflow threaded outlet but, if required, a 509 overflow assembly can be fitted. These sinks are designed for mounting on the underside of work surfaces.

Cat. No.	601
A	492mm
B	171mm
C	76 mm
D	241mm
H	32mm
gms	1030
Radius	36mm
Product Code	V460100

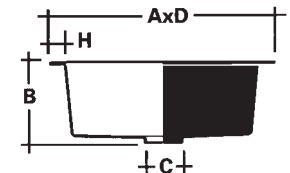

A = length D = width

602 Sink

The 602 sink is extremely robust and has a self-draining base. Its recessed outlet will accept the flange of the 1 1/2" BSP 504 non-overflow threaded outlet but, if required, a 509 overflow assembly can be fitted. These sinks are designed for mounting on the underside of work surfaces.

Cat. No.	602
A	552mm
B	231mm
C	74mm
D	400mm
E	152mm
H	35mm
gms	2668
Radius	35mm
Product Code	V460200

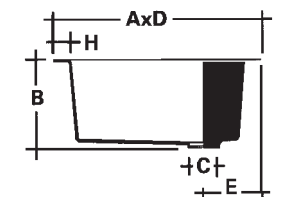

A = length D = width

603 Running Trough

Fabricated to customers specific requirements the running trough is manufactured with 3mm thick walls and is supplied complete with waste outlet - as specified - and supporting framework.

Cat. No.	603
A	127mm
B	210mm
C	1 1/2" BSP 2" BSP

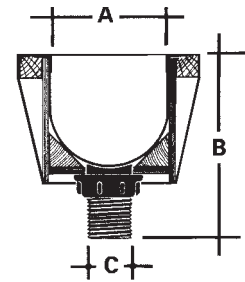

W561 Anti-Siphon Bottle Trap

Retaining its seal under the most demanding conditions this trap is completely dependable and is ideal for the most severe conditions. With a 76mm liquid seal, the base can be unscrewed from the body for easy cleaning. The trap has an adjustable height inlet for easier connection to Vulcathene waste pipe.

Provided with a purple coloured 1 1/2" BSP loose nut coupling for screwing to waste or drip cup tails, the 'P' outlet is supplied with nut and olive to take 38mm Vulcathene mechanical pipe. When required a W291/L291A 38mm bend will convert it to an 'S' trap.

Cat. No.	W561
A	77mm
B	203mm
C	141mm
D	90.5 mm
E	1 1/2" Mechanical thread
F	1 1/2" BSP
G	313mm
gms	300
Product Code	V1056101

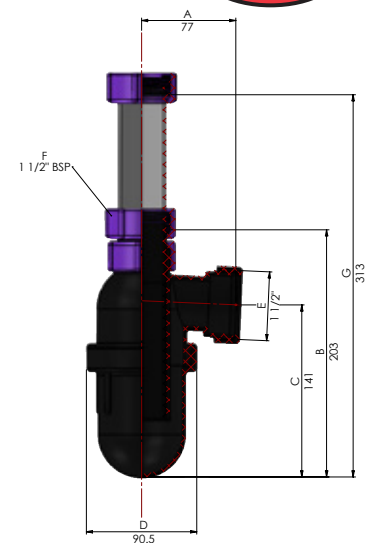

W681 Dilution Recovery Trap/Adjustable Inlet

Easily emptied, by unscrewing the base from the trap, this large capacity anti-siphonic dilution recovery trap has a 76mm liquid seal and holds 2.3 litres. The trap has an adjustable height inlet for easier connection to Vulcathene waste pipe. The 1 1/2" purple coloured BSP inlet includes a loose nut coupling for connection to a waste outlet or drip cup tail. The trap is supplied with a nut and olive to enable it to be 'P' trap configured for 38mm pipe. The addition of a W291 38mm bend will change the configuration to an 'S' trap.

Cat. No.	W681
A	77mm
B	329mm
C	267mm
D	141mm
E	1 1/2" Mechanical thread
F	1 1/2" BSP
G	439mm
gms	480
Product Code	V1068101

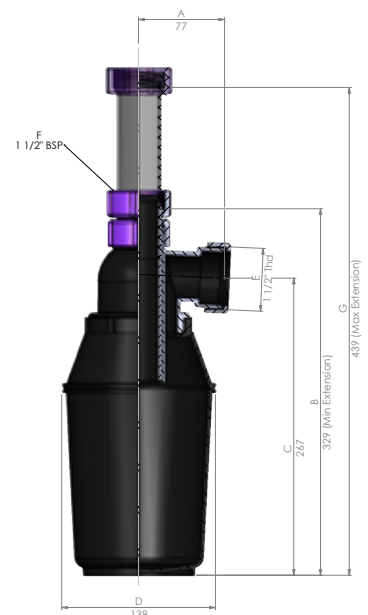

W691 Dilution Recovery Trap (Glass Base)

The 691 trap has a total capacity of 2.3 litres and a 76mm liquid seal.

The clear base of heat resistant, borosilicate glass makes this an ideal choice for use in waste systems which have to cope with large quantities of solid waste matter. The trap allows the volume of solids collected to be quickly assessed and, where necessary, cleared, before they can cause any damage to the system. It also allows the identification and recovery of valuable solids.

In order to remove the dilution chamber from the trap body, the glass unit should be unscrewed complete with its flange assembly. The 1½" BSP inlet includes a loose nut coupling for connection to a waste outlet or drip cup tail.

The trap is supplied with a nut and olive to enable it to be 'P' trap configured for 38mm pipe. The addition of a W291 38mm bend will change the configuration to an 'S' trap.

When installed it is important to support the underside of the trap (at least 76mm above the floor) to avoid weight strain on the pipework and connections.

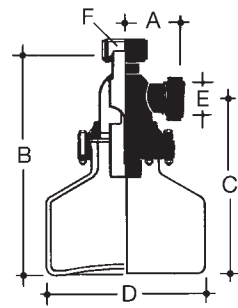

Cat. No.	W691
A	77mm
B	314mm
C	252mm
D	229mm
E	1½" Mechanical thread
F	1½" BSP
gms	2390
Product Code	V1069101

W571 Anti-Siphon Bottle Trap (Glass Base)

Retaining its seal under the most demanding conditions this trap is completely dependable and is ideal for the most severe conditions. With a 76mm liquid seal, the base can be unscrewed from the body for easy cleaning.

Provided with a 1½" BSP loose nut coupling for screwing to waste or drip cup tails, the 'P' outlet is supplied with nut and olive to take 38mm Vulcathene mechanical pipe. When required a W291/L291A 38mm bend will convert it to an 'S' trap.

The clear base of heat resistant, borosilicate glass makes this an ideal choice for use in waste systems which have to cope with large quantities of solid waste matter. The trap allows the volume of solids collected to be quickly assessed and, where necessary, cleared, before they can cause any damage to the system. It also allows the identification and recovery of valuable solids.

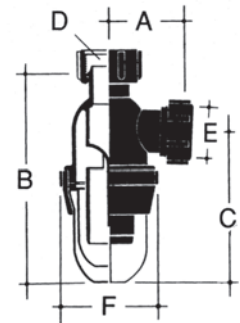

Cat. No.	W571
A	77mm
B	219mm
C	156mm
D	1½" BSP
E	1½" Mechanical thread
F	90mm
gms	923
Product Code	V1057101

W612 Dilution Recovery Trap

With a 4.5 litre capacity and a 76mm trap seal the W612 is particularly useful for those situations where under-bench height is limited.

When cleaning out the unit, union nuts on the lid should be disconnected, the dip tubes withdrawn and the interior of the dilution chamber carefully flushed out.

No attempt should be made to separate the lid from the dilution chamber.

For a 'P' outlet, a 51mm nut and olive is supplied, and for an 'S' outlet, add a W292 51mm bend.

Where it is intended to use the unit as a dilution chamber only, the dip tubes should be omitted. The unit is supplied with dip tubes, nuts, olives and blanking off plug. (Additional dip tubes and blanking off plugs can be ordered separately).

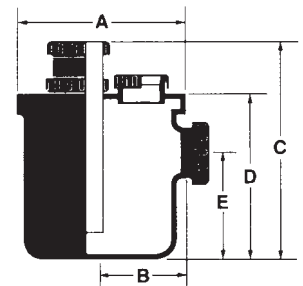

Cat. No.	W612
A	230mm
B	121mm
C	318mm
D	244mm
E	168mm
gms	2250
Product Code	V1061201

910G Dilution Recovery Trap (Glass Base)

With a 4.5 litre capacity and a 76mm trap seal the 910G, with its clear base of heat resistant, borosilicate glass allows the volume of solids collected to be quickly assessed and, where necessary, cleared. It also allows the identification and recovery of valuable solids. The new 910G is supplied with a removable lid & gasket seal, both held in place by a stainless steel clamp which can be easily removed for access & maintenance. Outlet connection is 51mm, with nut & olive supplied. Dip tubes, vertical inlets, horizontal inlets and blanking off plugs should be ordered separately.

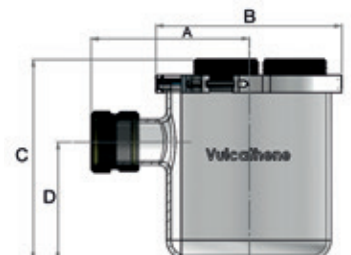

Cat. No.	910G
A	208mm
B	246mm
C	265mm
D	156mm
gms	4010
Product Code	V1910001

W915 Clay Trap

With a 20 litre capacity the 552 x 400 x 270mm deep clay trap incorporates inlet, and outlet connections at opposite ends, which accept W151 38mm FI BSP connectors. The outlet connection has a 76mm liquid seal and the lid, which has a sealing ring, is retained in position with fourteen wing nuts.

Cat. No.	W915
A	552mm
B	76mm
C	38mm
D	400mm
E	270mm
F	171mm
gms	8900
Product Code	V1091501

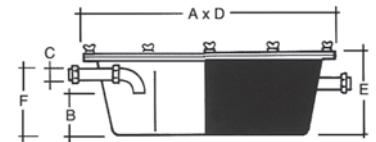

Trapped Floor Gully

The 4.5 litre trapped floor gully is fabricated from beige grey polypropylene and has a 76mm liquid seal. The removable grating gives easy access to the interior for cleaning.

The gully has a 76mm plain ended outlet for either Mechanical or Enfursion jointing. Additional side or back inlets in positions A, B or C (as indicated) can be supplied to order.

Note: Vulcathene floor gullies are fabricated to order.

Nom. Size	4.5 litres
A	250mm
L	320mm
D	89.0mm (Outside Diameter)
gms	3420
Product Code	V1810100

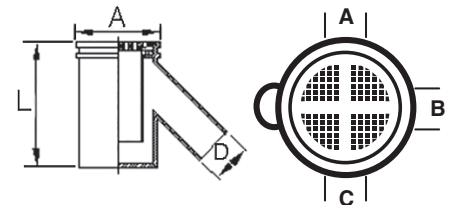

PC91 Pipe Clip

Of snap-on type these clips retain the pipe securely in place while allowing lateral movement of the pipe caused by fluctuations in thermal conditions.

Note: When 76mm and 102mm pipe are installed in long vertical runs considerable strain may be caused by thermal movement. In such conditions metal brackets should be used to retain the pipe, ie. Munson Ring.

Cat. No.	91			
Nom. Size	38mm	51mm	76mm	102mm
A	38mm	44mm	67mm	89mm
B	60mm	76mm	111mm	140mm
C	19mm	19mm	32mm	32mm
gms	32	52	82	120
Product Code	V5091101	V5091201	V5091301	V5091401

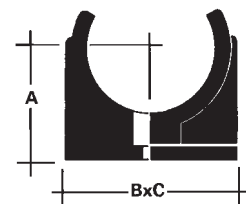

W916 Flexible Connector

Standard flexible connectors manufactured from polypropylene for use with mobile fume cupboards. The ends are pre-grooved with nut and olive supplied.

Product Code	Size	Length (m)
V5916001	38mm	1
V5916015	38mm	1.5
V5916002	38mm	2
V5916003	38mm	3

Note: Other lengths can be supplied to order



W465 Clamp Saddle

Clamp saddles enable easy connection of new branch pipes to existing Vulcathene stacks. The saddles have BSP female threaded outlets, nitrile seals, zinc plated hardware and are a charcoal grey colour supplied in four sizes. 76mm saddles are supplied with 4 x bolts; 102mm saddles with 6 x bolts.

For connection to 38mm and 51mm Vulcathene pipes use Vulcathene Mechanical or Enfusion male BSP adapters. (See clamp saddle installation information on Page 47)

Cat. No.	W465	Product Code
Sizes:	102mm x 2" BSP	gms: 540 V465050
	102mm x 1½" BSP	500 V465060
	76mm x 2" BSP	440 V465070
	76mm x 1½" BSP	430 V465080



W450 Air Admittance Valve

Air admittance valves enable Vulcathene stacks to be terminated inside the building thereby avoiding costly roof penetration. They are designed to prevent the release of foul air whilst admitting air under conditions of reduced pressure in discharge pipes preventing water seals in traps from being drawn. The valves also contribute to the ventilation of the main drain to which the discharge stack incorporating the valve is connected.

The Vulcathene air admittance valve is designed to suit 102mm Vulcathene pipe and incorporates a rubber finned tail for internal pipe connection and a removable screw cap for maintenance access.

To connect to a 76mm Vulcathene stack use a 102mm/76mm reducer and insert the valve into the 102mm socket. The AAV is approved to BS EN 12380 (B1)

Cat. No.	W450
Sizes:	102mm
A	245mm
B	60mm
C	135mm
gms	872
Product Code	V466040

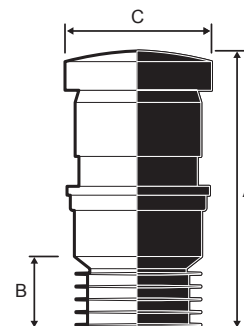

W50 Anti-Siphon Unit

Anti-siphon units are designed to prevent the release of foul air whilst admitting air under conditions of induced or self-siphonage in discharge pipes preventing water seals in traps from being drawn. The W50 is suitable for connection to 51mm Vulcathene pipe and incorporates a rubber seal which must first be inserted into the pipe followed by the anti-siphon unit. The anti-siphon unit is approved to BS EN12380 (A11)

Cat. No.	W50
Sizes:	51mm
A	61mm
B	22mm
C	36mm
Product Code	V467020

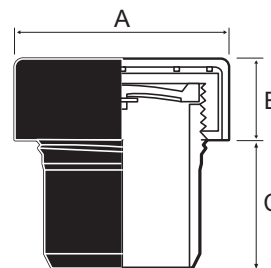

Galvanised Support Channel

A galvanised metal support channel, supplied in standard 2.5 metre lengths, should be used where Vulcathene pipework requires continuous support.

	Product Code
Sizes:	V465010
38mm	V465020
51mm	V465030
76mm	V465040
102mm	

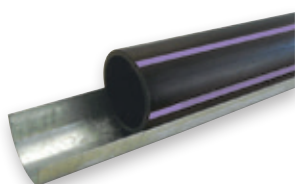

W641/W642 Horizontal Inlet

For use with 910G Dilution Recovery Traps to make a horizontal pipe connection.

Cat. No.	W641	W642
gms	148	207
Product Code	V1064101	V1064201



Vulcathene Lubricant

Supplied in 200g pots, Vulcathene lubricant should be applied to the threads of fittings before making a mechanical joint.

Product Code	V5900002
---------------------	----------



Glass Dip Tube

For use with 910G Dilution Recovery Traps

Product Code	V5913001
---------------------	----------



W651/W652 Vertical Inlet

For use with 910G Dilution Recovery Traps to make a vertical pipe connection.

Cat. No.	W651	W652
gms	97	135
Product Code	V1065101	V1065201



Blanking Off Plug

For use with 910G Dilution Recovery Traps

Product Code	V5912001
---------------------	----------



UniCollar® Fire Protection

UniCollar is a unique method of protecting Vulcathene pipes which pass through fire rated walls and floors. The system is supplied in continuous strip form which is cut to length and attached to the element using ready-made clips. These clips fit into the pre-punched slots on the strip.

UniCollar is packed in a box which contains 2250mm length of collar or 150 segments. The box has installation details on one face. The collar is designed so that it can be cut and snapped in segments of 15mm. One box is the equivalent of 5 x 102mm (114.3mm OD) Vulcathene collars.

Product Code	V468100
---------------------	---------

For details on fire rating and installation see pages 48 and 49.



DC95/DC115 Flexible Drain Coupling

For connecting 76mm and 102mm Vulcathene stacks to underground drainage systems of other materials where a flange connection is not available. Flexible drain couplings, with nitrile sleeves, incorporate medium duty stainless steel clamping bands at either end.

Cat. No.	DC95	DC115
Size range (mm)	80-95	100-115
Width (mm)	100	100
'T' (mm)	7	7
Application	75mm (3") ABS 75mm Cast Iron 75mm Ductile Iron	100mm PVC-U 100mm PE 100mm Stainless Steel
gms	402	435
Product Code	V100DC95	V100DC115



AC1221/AC1361 AC5144/AC1362 Flexible Adaptor Coupling

For connecting 76mm and 102mm Vulcathene stacks to underground drainage systems of other materials where a flange connection is not available. Flexible adaptor couplings have a stepped moulded nitrile sleeve with different diameters at each end to enable pipes of differing outside diameters to be jointed economically and quickly without the use of bushes. The sleeve is fitted with two stainless steel clamping bands by which they are secured to the pipe ends.

Cat. No.	AC1221	AC1361	AC5144	AC1362
Size range A/B (mm)	110-122/80-95	121-136/80-95	110-125/100-115	121-136/100-115
Width (mm)	100	100	100	100
Application (100mm)	PVC-U Cast Iron Supersleeve	Vitrified Clay Asbestos Cement Salt Glazed Ware	Supersleeve Cast Iron Ductile Iron Asbestos Cement	Vitrified Clay Salt Glazed Ware Asbestos Cement
gms	400	460	463	500
Product Code	V1AC1221	V1AC1361	V1AC5144	V1AC1362

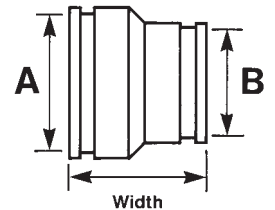

W18 92¹/₂° Bend

Both ends have standard nut and olive connections.

Cat. No.	W181	W182	W183	W184
Nom. Size	38mm	51mm	76mm	102mm
A	43mm	64mm	86mm	100mm
gms	64	113	343	625
Product Code	V1018101	V1018201	V1018301	V1018401

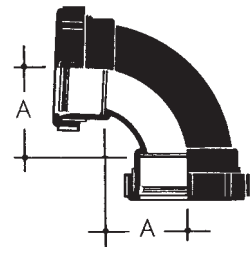

W29 92¹/₂° Loose Nut Sweep Bend

One end has the standard nut and olive connection whilst the other has a captive nut for connection to threaded units.

Cat. No.	W291	W292	W293	W294
Nom. Size	38mm	51mm	76mm	102mm
A	54mm	64mm	87mm	104mm
B	65mm	93mm	136mm	167mm
gms	68	109	338	613
Product Code	V1029101	V1029201	V1029301	V1029401

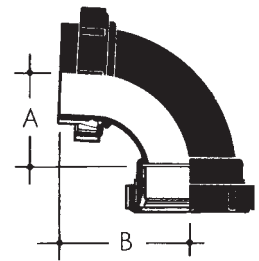

W19 135° Slow Bend

Both ends have standard nut and olive connections

Cat. No.	W191	W192	W193	W194
Nom. Size	38mm	51mm	76mm	102mm
A	15mm	16mm	51mm	48mm
gms	75	120	291	900
Product Code	V1019101	V1019201	V1019301	V1019401

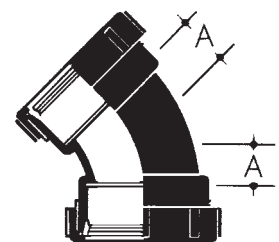

W21 135° Loose Nut Slow Bend

One end has the standard nut and olive connection whilst the other has a captive nut for connection to threaded units.

Cat. No.	W211	W212	W213	W214
Nom. Size	38mm	51mm	76mm	102mm
A	44mm	44mm	102mm	114mm
B	15mm	18mm	51mm	45mm
gms	44	66	294	468
Product Code	V1021101	V1021201	V1021301	V1021401

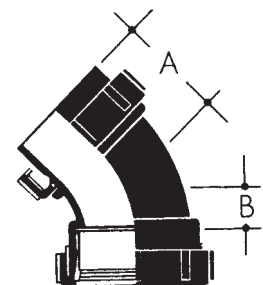

W20 92^{1/2}° Equal Sweep Tee

The three equal sized ends have standard nut and olive connections.

Cat. No.	W201	W202	W203	W204
Nom. Size	38mm	51mm	76mm	102mm
A	59mm	62mm	83mm	98mm
B	39mm	52mm	39mm	76mm
C	97mm	114mm	122mm	175mm
gms	104	160	471	860
Product Code	V1020101	V1020201	V1020301	V1020401

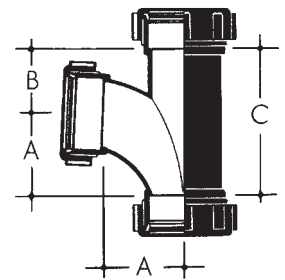

W20 92^{1/2}° Reducing Sweep Tee

The two equal and one reduced sized ends have standard nut and olive connections.

Cat. No.	W2021
Nom. Size	51x38mm
A	58mm
B	45mm
C	114mm
gms	146
Product Code	V1020211

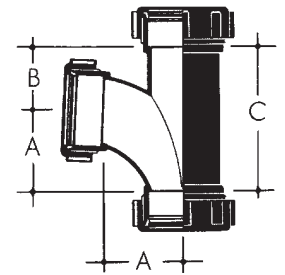

W37 45° Single Wye

The three equal sized ends have standard nut and olive connections.

Cat. No.	W371	W372	W373	W374
Nom. Size	38mm	51mm	76mm	102mm
A	86mm	91mm	177mm	213mm
B	64mm	76mm	152mm	178mm
C	8mm	17mm	43mm	49mm
gms	96	151	650	1087
Product Code	V1037101	V1037201	V1037301	V1037401

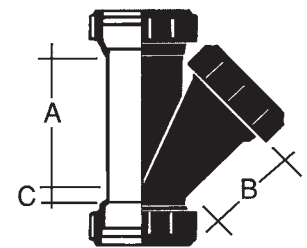

W38 45° Double Wye

Available in all sizes. The four equal sized ends have standard nut and olive connections.

Cat. No.	W381	W382	W383	W384
Nom. Size	38mm	51mm	76mm	102mm
A	86mm	91mm	177mm	213mm
B	64mm	76mm	152mm	178mm
C	8mm	17mm	43mm	49mm
gms	180	228	800	1600
Product Code	V1038101	V1038201	V1038301	V1038401

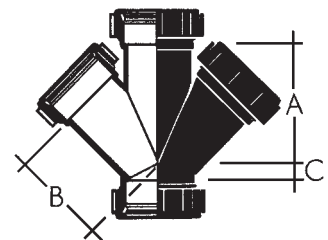

W942 90° Corner Branch

The 90° Corner branch is available in size 102mm x 51mm with spigot ends for either Mechanical or Enfusion jointing. The 51mm branches are at 92½° to the main bore. Additional nuts and olives are required for Mechanical jointing unless connecting to another Vulcathene Mechanical fitting. For 38mm branch connections use Vulcathene W3921 reducers.

Cat. No.	W942
Sizes:	102mm x 51mm
A	250mm
B	114.3mm
C	60.3mm
D	62.9mm
gms	480
Product Code	V1094201

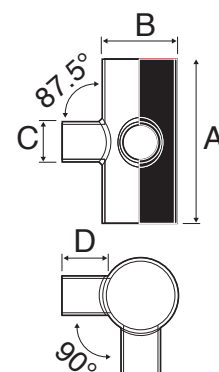

W70 'U' Bend

Available in 38mm and 51mm sizes the 'U' bend can be combined with other standard fittings from the range to make up 'P', 'S' and Running Traps with a 76mm trap seal.

In order to make up both 'P' and 'S' configurations the addition of a length of Vulcathene mechanical pipe, and a W15 coupler, to one end enables it to be connected to the waste fitting whilst the addition of a W29 loose nut sweep bend converts it into a 'P' trap.

The addition of a further W29 make it into a 'S' trap. Connecting a W29 to each end of the 'U' bend makes up a running trap.

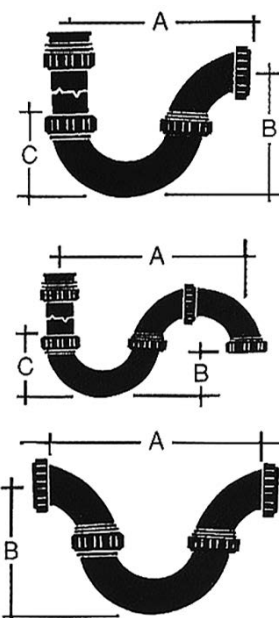

Cat. No.	'P' Trap		'S' Trap		'Running' Trap	
	38mm	51mm	38mm	51mm	38mm	51mm
Nom. Size	219mm	259mm	235mm	273mm	199mm	231mm
A	136mm	171mm	85mm	75mm	136mm	171mm
B	84mm	100mm	84mm	100mm		
C						
gms	140 (38mm)	236 (51mm)				

Product Code	38mm	V1070101
	51mm	V1070201

Component fittings required for:

Nom. Size	'P' Trap*		'S' Trap*		'Running' Trap	
	38mm	51mm	38mm	51mm	38mm	51mm
Cat No.	W151	W152	W151	W152	W701	W702
Cat No.	W291	W292	2 x W291	2 x W292	2 X W291	2 x W292
Cat No.	W701	W702	W701	W701	-	-

* Short length of Vulcathene pipe required.

W16 Line Coupler

For connecting equal sized pipes together. Supplied with two nuts and olives.

Cat. No.	W161	W162	W163	W164
Nom. Size	38mm	51mm	76mm	102mm
B	3mm	3mm	6mm	6mm
gms	29	46	183	301
Product Code	V1016101	V1016201	V1016301	V1016401



W39 Reducing Coupler

The six reducing couplers which cover the range all have nut and olive connections on the small diameter end while the spigot end is grooved, ready to accept the nut and olive from the fitting which is to be reduced.

Cat. No.	W3921	W3931	W3932
Nom. Size	51 x 38mm	76 x 38mm	76 x 51mm
A	40mm	60mm	57mm
gms	44	95	102
Product Code	V1039211	V1039311	V1039321

Cat. No.	W3941	W3942	W3943
Nom. Size	102 x 38mm	102 x 51mm	102 x 76mm
A	97mm	89mm	71mm
gms	180	186	251
Product Code	V1039411	V1039421	V1039431

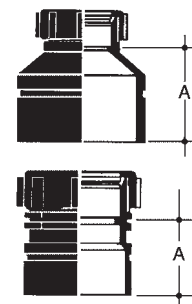

(W3921 only)

W14 M.I. to Pipe Coupler

With standard BSP parallel threads the W14 Pipe Coupler can be screwed direct into the F.I. fittings of metal or plastic pipes.

Cat. No.	W141	W142
Nom. Size	38mm	51mm
A	1 1/2" BSP	2" BSP
B	6mm	6mm
gms	31	53
Product Code	V1014101	V1014201

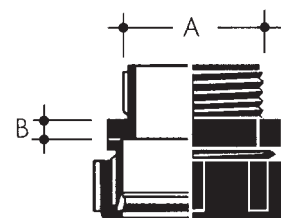

W15 F.I. to Pipe Coupler

With standard BSP parallel threads the W15 Pipe Coupler can be screwed directly to M.I. ends of metal or plastic pipes. The 38mm unit can be screwed to the threaded tail of a waste or drip cup when a pipe connection is required.

The 51mm unit can be screwed to the threaded tail of a 51mm waste.

Cat. No.	W151	W152
Nom. Size	38mm	51mm
A	1 1/2" BSP	2" BSP
B	3mm	3mm
gms	35	52
Product Code	V1015101	V1015201

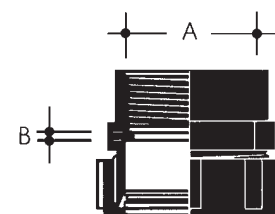

W271 1 3/4" F.I. to Pipe Coupler

Made in one size only, this fitting should be used when joining 38mm Vulcathene Mechanical pipe to 38mm Vulcathene Polyfusion pipe. It may also be screwed to the outlet of any Vulcathene Polyfusion trap to provide a connection for 38mm Mechanical pipe.

Cat. No.	W271
Nom. Size	38mm
A	1 3/4" BSP
B	5mm
gms	32
Product Code	V1027101

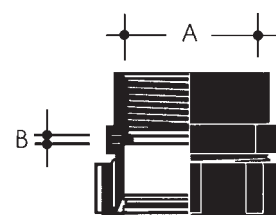

W121 1 1/4" F.I. x 1 1/2" M.I. BSP Reducer

Note: Used when joining the Vulcathene mechanical system to a 1 1/4" BSP waste tail. When making a connection to pipe a W151 38mm F.I. coupler should first be added to the outlet of a W121 reducer. Alternatively, the outlet of W121, which has a standard 1 1/2" BSP parallel thread, will accept the connecting nut of any of the Vulcathene traps illustrated in this catalogue.

Cat. No.	W121
Nom. Size	38mm
A	32mm
gms	27
Product Code	V1012101



W45 Glass Adaptor

Used when joining the Vulcathene mechanical system to a glass drainage system. Available in Flame Retardant Polypropylene (FRPP) only.

Cat. No.	W451	W452	W453	W454
Nom. Size	38mm	51mm	76mm	102mm
A	28mm	31mm	44mm	44mm
gms	37	63	192	317
Product Code	V1045104	V1045204	V1045304	V1045404

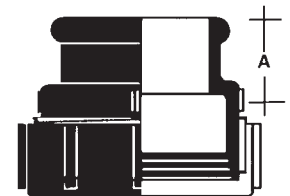

W801 Thermal Stress Relief Unit

The W801 can be installed either vertically or horizontally. When installed it is important to ensure that the end with the moulded fixing clip is the outflow end of the fitting.

Cat. No.	W801
Nom. Size	38mm
A min	70mm
A max	108mm
Product Code	V1011101

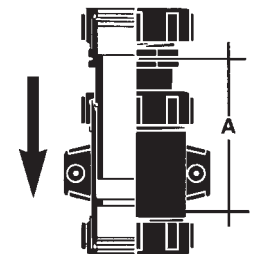

W802 Thermal Stress Relief Unit

The W802 can be installed either vertically or horizontally. When installed it is important to ensure that the end which forms the collar is the outflow end of the fitting.
 The W802 SRU is supplied with 51mm mechanical Pipe Couplers at each end.
 The unit must be anchored with a metal clamp which should be located round the body of the SRU, just below the ridge round the top of the collar. This allows the pipe inserted into the collar to move freely.

Cat. No.	W802
Nom. Size	51mm
A min	149mm
A max	203mm
B	73mm
gms	243
Product Code	V5452201

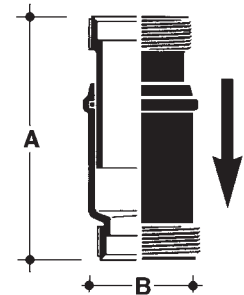

W803/W804 Thermal Stress Relief Unit

The W803 and W804 unit can be installed either vertically or horizontally. When installed it is important to ensure that the spigot end is the outflow end of the fitting.
 The unit must be anchored with a metal clamp which should be located on top of the moulded locators round the body of the SRU, which then allows the pipe inserted into the collar to expand and contract.
 The body of the SRU incorporates an O-ring seal.

Cat. No.	W803	W804
Nom. Size	76mm	102mm
A	196mm	215mm
B	117.2mm	144.5mm
C	110mm	141mm
D	101.7mm	129mm
E	89.7mm	115mm
gms	575	900
Product Code	V1080301	V1080401

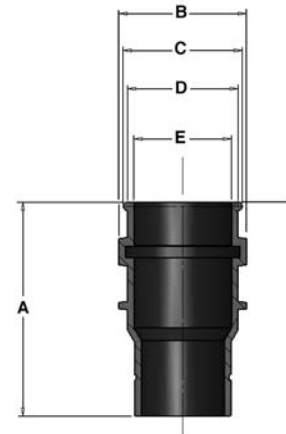

W90 Access Pipes

Correctly sited at critical points in the pipeline, access pipes simplify the clearing of blockages, inspection and thorough cleansing of the installation. With a clear flow bore, the W90 series access pipes have a bolt on cover and grooved spigot ends to accept nut and olive connection to the Vulcathene Mechanical System.

Cat. No.	W902	W903	W904
Nom. Size	51mm	76mm	102mm
A	260mm	302mm	390mm
B	164.2mm	164.2mm	218.6mm
C	114.4mm	114.4mm	138.8mm
D	145mm	145mm	179mm
Product Code	V1090201	V1090301	V1090401

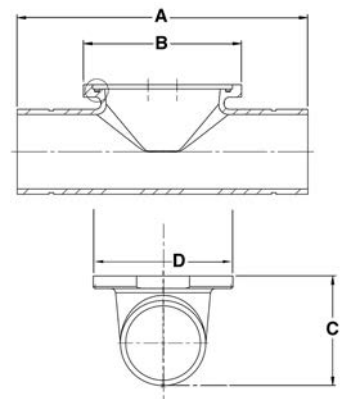

W100 BS Table D Flange (Undrilled)

This allows the removal of complete pipe sections for ease of maintenance. It can also be used when connected to another BS Table D Flange.
 The BS Table D Flanges should be clamped together with a nitrile gasket and 4 x M20 bolts.

Cat. No.	W101T.D	W102T.D	W103T.D	W104T.D
Nom. Size	38mm	51mm	76mm	102mm
A	30mm	30mm	41mm	41mm
B	133mm	152mm	187mm	216mm
C	16mm	16mm	19mm	19mm
gms	300	409	1500	2087
Product Code	V1010101	V1010201	V1010301	V1010401

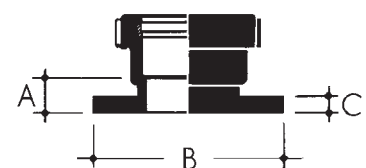

W22 Olive

The new flexible no heat Vulcathene olive locates into a groove, cut into the pipe using the cutting tool W26, by means of a 'tongue' around its inner surface. This simple, yet highly effective olive is then forced into the space between the pipe and the fitting as the nut is tightened thus forming a highly effective liquid tight seal.



Cat. No.	W221	W222	W223	W224
Nom. Size	38mm	51mm	76mm	102mm
gms	2	3	51	91
Product Code	V1022111	V1022211	V1022311	V1022411

W23 Nut

Vulcathene nuts are used in conjunction with the Vulcathene olive to make a watertight joint. Every Vulcathene Mechanical fitting is supplied complete with Vulcathene nuts. We recommend that Vulcathene lubricant is smeared on the thread to facilitate tightening of the joint using the purpose-designed W36 spanner.

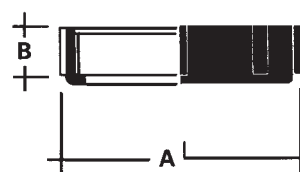

Cat. No.	W231	W232	W233	W234
Nom. Size	38mm	51mm	76mm	102mm
A	67mm	83mm	134mm	162mm
B	21mm	25mm	33mm	35mm
gms	58	100	250	520
Product Code	V1023101	V1023201	V1023301	V1023401

W24 Blanking-Off Plug

Made to suit all pipe sizes, blanking-off plugs should be used where a rodding point is required in the waste pipe run and also for blanking off inlets of a W612 Dilution Recovery Trap. With its own tapered sealing surface, it replaces the olive, and is held into the fitting by the nut.



Cat. No.	W241	W242	W243	W244
Nom. Size	38mm	51mm	76mm	102mm
gms	38	64	109	196
Product Code	V1024101	V1024201	V1024301	V1024401

W26 Groove Cutting Tool

Vulcathene grooving tools enable a groove, of the exact depth and width, to be cut in the correct location from the end of the pipe where the mechanical olive is then located.

Cat. No.	W261	W262	W263	W264
Nom. Size	38mm	51mm	76mm	102mm
gms	100	146	368	719
Product Code	V1026101	V1026201	V1026301	V1026401



38/51mm



76/102mm

W36 Spanner

This moulded polycarbonate spanner is made specifically for use with the Vulcathene Mechanical range and should always be used to tighten the Vulcathene nuts as it will not distort or damage the nuts in the process of achieving a secure joint.



Cat. No.	W361	W362	W363	W364
Nom. Size	38mm	51mm	76mm	102mm
gms	81	110	199	269
Product Code	V1036101	V1036201	V1036301	V1036401

C130 Half Coupler

Used to convert 38mm Polyfusion pipe to 38mm Mechanical pipe, the threaded end can be screwed to a W271 1 3/4" pipe coupler to make a mechanical joint.

Cat. No.	C130
Nom. Size	38mm
A	45mm
gms	40
Product Code	V5130101

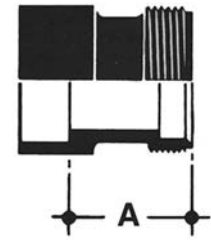

P758 BSP Coupler

Used to convert 38mm Polyfusion pipe to Mechanical (or Enfusion) pipe, the BSP threaded end can be screwed to W15 or L15 series female couplers.

Cat. No.	P758
Nom. Size	38mm
A	35mm
B	41mm
gms	36
Product Code	V5758101

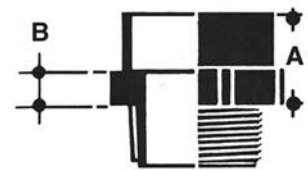

200 Hand Tool

Used for making socket fusion joints in 38mm, the tool can be heated to the required temperature using a gas torch.
(See polyfusion jointing information on Page 51).

	Product Code
38mm	V440010



Pipe Cutters

	Product Code
16-63mm pipe cutter	FT800001
50-125mm pipe cutter	FT800003
16-63mm spare cutter wheel	FT800002
50-125mm spare cutter wheel	FT800004



Vulcathene Chemical Waste Drainage System

Mechanical Drainage Design

A typical laboratory bench waste run, incorporating drip cups discharging into bottle traps and then into a Vulcathene stack.

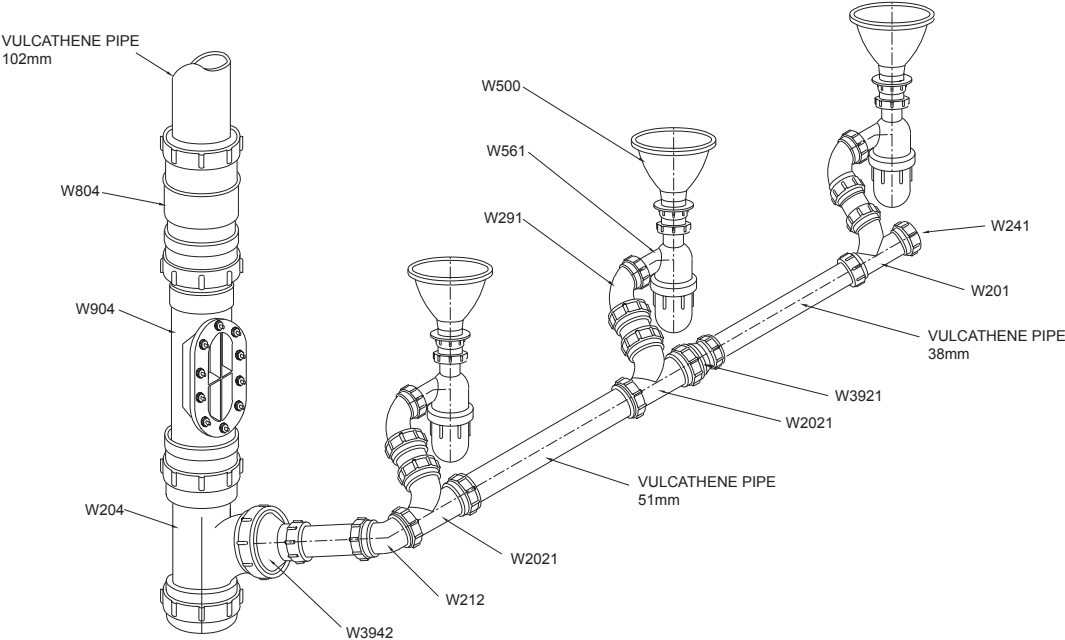

A typical laboratory bench waste run, incorporating sinks discharging into a Dilution Recovery Trap.

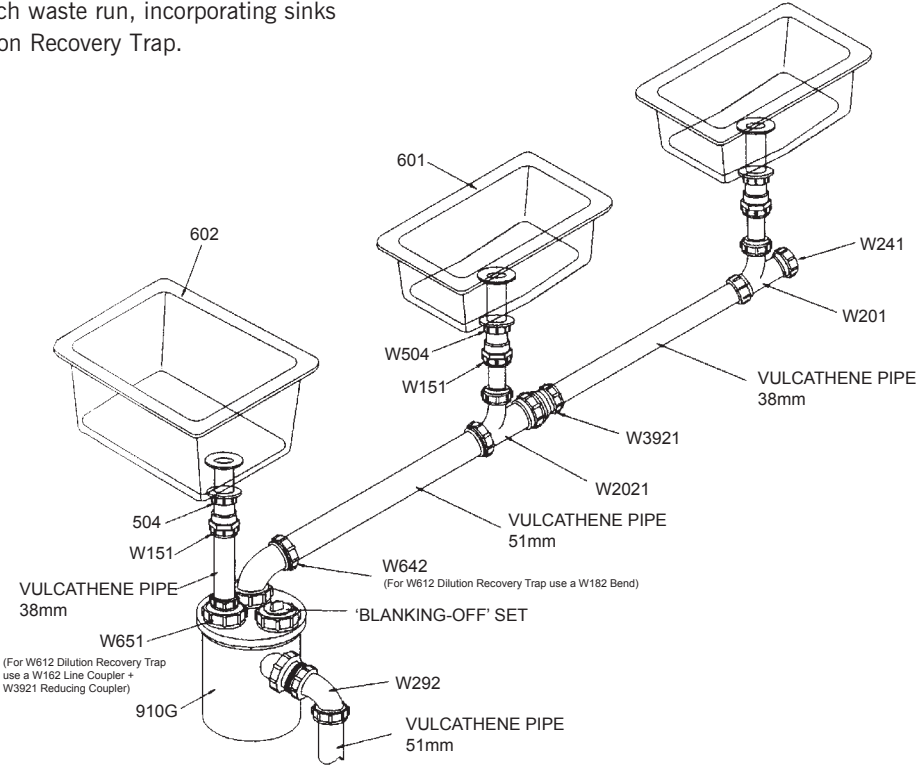

Vulcathene Chemical Waste Drainage System

Making the Mechanical Joint

The Mechanical joint employs a moulded tongued thermo plastic elastomer olive which is 'keyed' to the pipe by a patented technique and takes, on average, only about half a minute to make. Once the nut is tightened and the joint is made, the pipe is locked into the fitting to give a lasting leak-free connection. The joint is demountable for maintenance or system re-design purposes, and can be made and re-made.

Note: always tighten the nuts as work progresses. They should not be left until the job is completed. When installing any chemical waste drainage system it is imperative in order to ensure that joint integrity can be maintained, in line with the design criteria of the system, Vulcathene grooving tools and spanners must be used to make the joint.

While the general principles of waste drainage still apply when jointing Vulcathene chemical waste drainage, considerable care must be taken in making the joint. When tightening a fitting made from Polypropylene the two 'dry' surfaces of the material tend to 'bind' against each other preventing the nuts on the joints being fully tightened.

To overcome this, either Vulcathene lubricating grease or petroleum jelly should be smeared onto the threads of the joint. This will enable the nut to be tightened to its full thread capacity.

W36 Series Spanners

The W36 spanner, moulded from a polycarbonate, is made specifically for use with the Vulcathene Mechanical range and should always be used to tighten the Vulcathene joint as it will not distort, damage or scar the nut. A standard spanner or strap wrench should not be used as the 'squeezing' action can distort the fitting and the pressure applied is only effectively in contact with two of the lugs on the nut.

The W36 spanner has been designed with a profile that matches the moulded shape of the nut on the Vulcathene joint. The toe of the spanner should be located over a convenient lug on the nut and the action of tightening, or loosening, the nut will ensure that the spanner maintains full contact grip evenly against 5 of the nut lugs.

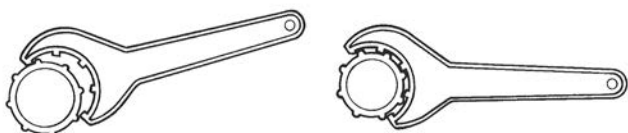

It is also important to remember that the nut should not be overtightened and the leverage length' of the hands will provide sufficient force to tighten the nut and produce full joint integrity. At no time should the 'handle' of the spanner be lengthened, with a pipe or other tool, to increase the leverage when tightening a nut.

We suggest that two spanners are used when tightening the nuts. One should be placed on the nut on the opposing end of the joint to counter the force applied, enabling the nuts to be tightened to their fullest capacity.

W26 Series Groove Cutting Tools

The major factor in the joint integrity of the Vulcathene Mechanical waste drainage system is the 'tongued olive'. Therefore, we have designed a tool which very simply enables a groove, of the exact depth and width, to be cut in the correct location from the end of the pipe.

The groove cutting tools for this purpose are specific to each size of pipe. While each of the cutting tools for 76 and 102mm pipe is provided with two handles, and requires the pipe to be held in a vice, the cutting tool for 38 and 51mm pipe, can be used by holding the pipe with one hand and operating the grooving tool with the other.



When securing the pipe in a vice, care must be taken to ensure that the pressure applied is sufficient to hold the pipe without distorting it. On all the groove cutting tools the depth of the grooving blade can be changed from full to half depth and we recommend that the first few turns should be made with the blade setting at half depth.

38mm (1½") and 51mm (2")

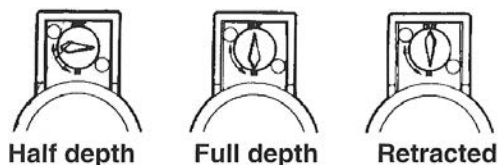

76mm (3") and 102mm (4")

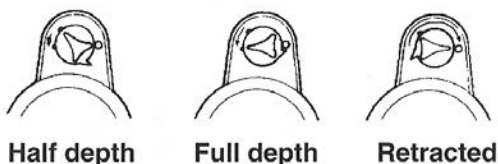

With the groove cutting tool for the large size pipes, it is important to grip the handles with both hands to ensure that it remains square to the end of the pipe, and cuts a uniform groove round the pipe.

Note: Groove cutting tools need to be in good condition in order to cut grooves of a constant and correct depth.

Vulcathene Chemical Waste Drainage System

Making the Joint

Clamp the pipe in a pipe vice. Cut to length using a rotary plastic pipe cutter as shown. This is favoured over the use of a hacksaw as the finish is clean (no loose swarf or burr on the pipe) and, more importantly, it is square and does not require further preparation. If a saw is used, it is essential that all burrs and loose material are removed.



To achieve full joint integrity it is necessary that a groove, into which the 'tongued' olive locates is cut around the pipe with the special grooving tool. Insert the pipe into the grooving tool to its total depth and adjust the depth cutting blade to half depth and revolve the cutting tool anti-clockwise around the pipe. Then adjust to full depth, again revolving it anti-clockwise. When completed retract the blade and remove the tool making sure that any swarf created by the grooving action is removed. Never try to cut the groove with the blade at full cut first time.



No-heat olives (yellow colour) have been developed for Vulcathene making joint assembly even quicker. To assemble the joint place the nut onto the pipe and slide the new no-heat olives wide end first into place, with the tongue locating into the groove in the pipe.

Note: Use Vulcathene lubricant on 76mm & 102mm Olives to aid installation.

Having made sure that the fitting is clean, smear Vulcathene Lubricant or petroleum jelly onto the threads of the fitting.



Loosely assemble the joint and proceed to hand tighten the knurled nut. Using two Vulcathene spanners further tighten the joint. The nut must be tightened to its full thread capacity.

38mm (1 1/2") and 51mm (2")

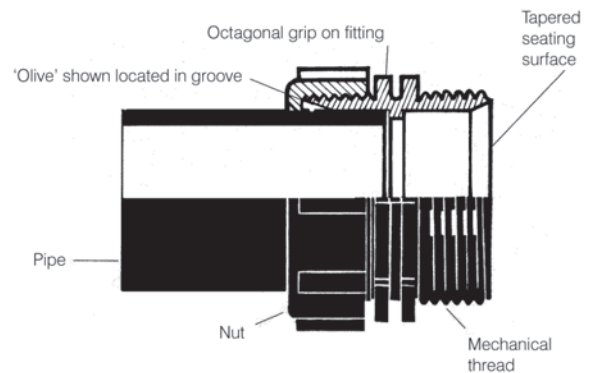

76mm (3") and 102mm (4")

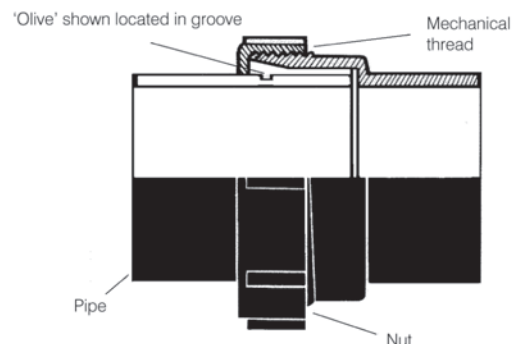

L28 Single Socket Long Sweep Bend

Available in sizes from 38mm to 152mm, this fitting has an Enfusion socket at one end and a plain spigot at the other.

Cat. No.	L281	L282	L283	L284	L286
Nom. Size	38mm	51mm	76mm	102mm	152mm
A	70mm	83mm	103mm	125mm	167mm
B	117mm	117mm	171mm	203mm	247mm
gms	90	170	350	510	2000
Product Code	V6028101	V6028201	V6028301	V6028401	V6028601

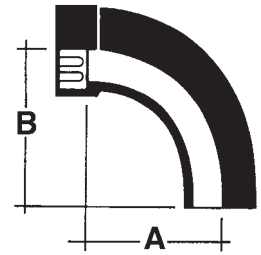

L29 Single Socket Short Sweep Bend

Available in 38mm and 51mm sizes this fitting has an Enfusion socket at one end and a plain spigot at the other.

Cat. No.	L291	L292
Nom. Size	38mm	51mm
A	43mm	64mm
B	75mm	97mm
gms	90	120
Product Code	V6029101	V6029201

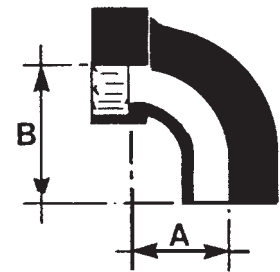

L291A Loose Nut/Socket Short Sweep Bend

Available in 38mm size only, this fitting has a captive nut for connection to Vulcathene threaded units at one end and an Enfusion socket at the other.

Cat. No.	L291A
Nom. Size	38mm
A	44mm
B	76mm
gms	90
Product Code	V6029111

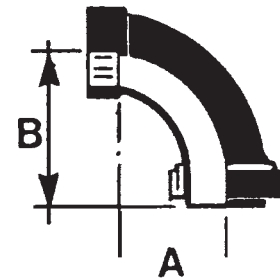

L17 Double Socket Long Sweep Bend

Available in sizes from 38mm to 152mm, this fitting has an Enfusion socket at both ends.

Cat. No.	L171	L172	L173	L174	L176
Nom. Size	38mm	51mm	76mm	102mm	152mm
A	70mm	83mm	103mm	125mm	198mm
gms	101	170	390	530	1760
Product Code	V6017101	V6017201	V6017301	V6017401	V6017601



L18 Double Socket Short Sweep Bend

Available in 38mm and 51mm sizes, this fitting has Enfusion sockets at both ends.

Cat. No.	L181	L182
Nom. Size	38mm	51mm
A	43mm	64mm
gms	115	172
Product Code	V6018101	V6018201

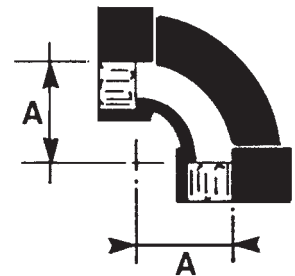

L19 45° Double Socket Slow Bend

Five standard sizes cover the 38mm to 152mm range, with an Enfusion socket at each end.

Cat. No.	L191	L192	L193	L194	L196
Nom. Size	38mm	51mm	76mm	102mm	152mm
A	19mm	38mm	51mm	51mm	43mm
gms	80	120	300	520	1500
Product Code	V6019101	V6019201	V6019301	V6019401	V6019601

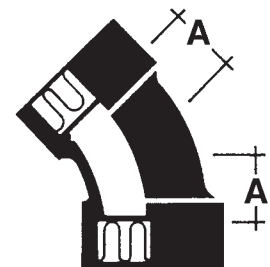

L21 45° Single Socket Slow Bend

Available in five sizes to suit standard 38mm to 152mm pipe the fitting has an Enfusion socket at one end and a plain spigot at the other end.

Cat. No.	L211	L212	L213	L214	L216
Nom. Size	38mm	51mm	76mm	102mm	152mm
A	19mm	38mm	51mm	51mm	43mm
B	38mm	76mm	95mm	100mm	114mm
gms	80	130	260	450	1450
Product Code	V6021101	V6021201	V6021301	V6021401	V6021601

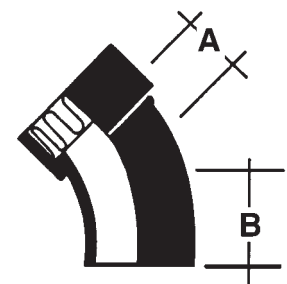

L20 92¹/₂° Equal Sweep Tee

An equal three branch fitting, the sweep tee is available in four sizes from 38mm to 102mm and has an Enfusion socket on each branch.

Cat. No.	L201	L202	L203	L204
Nom. Size	38mm	51mm	76mm	102mm
A	57mm	59mm	79mm	98mm
B	70mm	59mm	78mm	98mm
C	51mm	35mm	46mm	57mm
D	121mm	94mm	124mm	156mm
gms	103	220	560	1300
Product Code	V6020101	V6020201	V6020301	V6020401

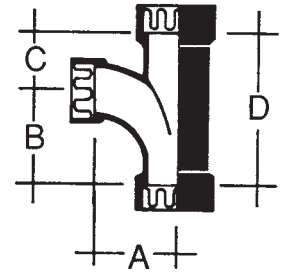

L20 92¹/₂° Reducing Sweep Tee

When ordering, the first two dimensions on the chart below relate to the straight through bore, and the third to the branch diameter.

Cat. No.	L2021	L2042
Nom. Size	51x51x38mm	102x102x51mm
A	57mm	100mm
B	70mm	52mm
C	51mm	28mm
D	121mm	81mm
gms	140	550
Product Code	V6020211	V6020421

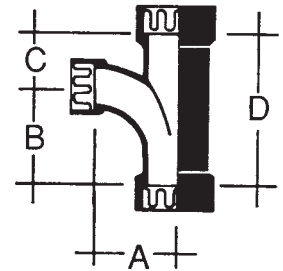

Note: To make other sizes in reduced tees use equal tees and the appropriate reducers.

L37 45° Single Wye

Covering the sizes from 38mm to 152mm all branches have an Enfusion socket.

Cat. No.	L371	L372	L373	L374	L376
Nom. Size	38mm	51mm	76mm	102mm	152mm
A	83mm	92mm	127mm	212mm	214mm
B	29mm	36mm	41mm	46mm	44mm
C	83mm	92mm	127mm	187mm	214mm
gms	200	240	550	1100	3630
Product Code	V6037101	V6037201	V6037301	V6037401	V6037601

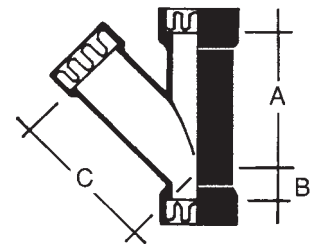

L37 45° Reducing Wye

For ordering the first two dimensions shown on the chart below relate to the straight through bore and the third the branch diameter. All branches have an Enfusion socket.

Cat. No.	L3721	L3731	L3732	L3742	L3764
Nom. Size	51x51x38mm	76x76x38mm	76x76x51mm	102x102x51mm	152x152x102mm
A	84mm	144mm	144mm	165mm	214mm
B	27mm	22mm	22mm	10mm	44mm
C	87mm	178mm	146mm	165mm	214mm
gms	170	700	520	814	2360
Product Code	V6037211	V6037311	V6037321	V6037421	V6037641

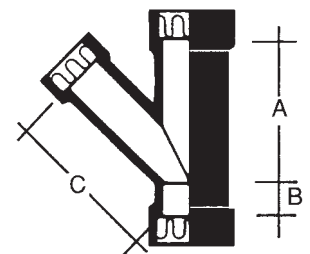

Note: To make other sizes in reduced tees use equal tees and the appropriate reducers.

L35 92¹/₂° Double Branch

An equal four branch fitting, the double branch is available in three sizes from 51mm to 102mm and has an Enfusion socket on each branch.

Cat. No.	L352	L353	L354
Nom. Size	51mm	76mm	102mm
A	58mm	78mm	98mm
B	59mm	79mm	98mm
C	35mm	46mm	57mm
D	93mm	124mm	156mm
gms	370	650	900
Product Code	V6035201	V6035301	V6035401

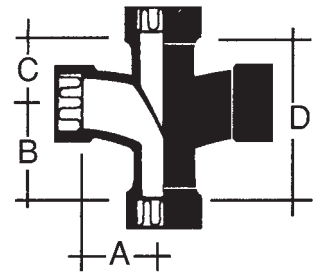

L942 90° Corner Branch*

The 90° Corner branch is available in size 102mm x 51mm with spigot ends for either Enfusion or Mechanical jointing. The 51mm branches are at 92¹/₂° to the main bore. Additional Enfusion couplers are required for Enfusion jointing unless connecting to another Vulcathene Enfusion fitting. For 38mm branch connections use Vulcathene L3912 reducers.

*Fabricated

Cat. No.	W942
Sizes	102mm x 51mm
A	250mm
B	114.3mm
C	60.3mm
D	62.9mm
gms	480
Product Code	V1094201

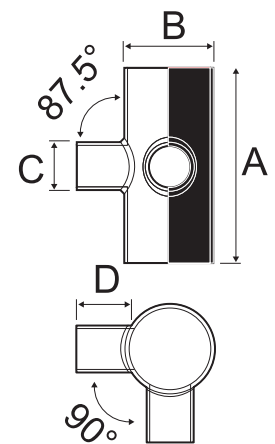

L101 U Bend

Available in 38mm and 51mm sizes, this fitting has Enfusion sockets at both ends. A 'P' trap configuration can be made by adding an L28 single socket sweep bend.

Cat. No.	L1011	L1012
Nom. Size	38mm	51mm
A	57mm	87mm
B	82mm	125mm
gms	150	200
Product Code	V6010111	V6010121

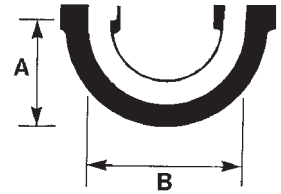

Note: 'P' traps in 76mm, 102mm and 152mm sizes can be made using 2 x L28 single socket bends plus 1 x L17 double socket bend.

L16 Coupling

Produced to fit the five sizes of the Enfusion chemical waste drainage system, from 38mm to 152mm, the coupling has an internal stop which forms a smooth through-bore and ensures that the correct depth of pipe is inserted into the fitting.

Cat. No.	L161	L162	L163	L164	L166
Nom. Size	38mm	51mm	76mm	102mm	152mm
A	6mm	8mm	11mm	11mm	13mm
B	61mm	74mm	102mm	127mm	183mm
gms	50	80	300	510	640
Product Code	V6016101	V6016201	V6016301	V6016401	V6016601

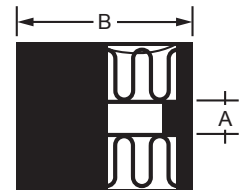

L16 (S) Slip Coupling

Enfusion slip couplers in sizes 102mm and 152mm can be used where a new branch connection to an existing Vulcathene stack is required.

Cat. No.	L164(S)	L166(S)
Nom. Size	102mm	152mm
B	150mm	150mm
gms	646	930
Product Code	V6716401	V6416601

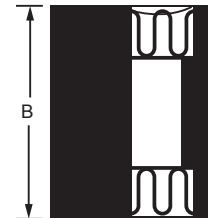

L39 Reducing Coupler

This range covers the requirement for changing from one pipe size to another. Designed with an Enfusion socket on one end and the other spigot end is fused into a larger Enfusion socket.

Cat. No.	L3912	L3923	L3924
Nom. Size	51x38mm	76x51mm	102x51mm
A	32mm	43mm	51mm
gms	44	160	239
Product Code	V6039121	V6039231	V6039241

Cat. No.	L3934	L3946
Nom. Size	102x76mm	152x102mm
A	47mm	64mm
gms	214	620
Product Code	V6039341	V6039461

Note: 76mm x 38mm reducer: Use L3923 reducer + L3912 reducer
 102mm x 38mm reducer: Use L3924 reducer + L3912 reducer
 152mm x 38mm reducer: Use L3946 reducer + L3924 reducer + L3912 reducer
 152mm x 51mm reducer: Use L3946 reducer + L3924 reducer
 152mm x 76mm reducer: Use L3946 reducer + L3934 reducer



L14 M.I to Pipe Coupler

In two sizes, 38mm and 51mm, this fitting has an Enfusion socket on one end and a male thread the other.

Cat. No.	L141	L142
Nom. Size	38mm	51mm
A	6mm	6mm
gms	30	60
Product Code	V6014101	V6014201



L15 F.I to Pipe Coupler

In two sizes, 38mm and 51mm, this fitting has an Enfusion socket on one end and a female thread the other.

Cat. No.	L151	L152
Nom. Size	38mm	51mm
A	8mm	8mm
gms	70	100
Product Code	V6015101	V6015201



L45 Glass Adaptor

Produced in flame retardant PP in four sizes from 38mm to 102mm, the fitting has an Enfusion socket on one end and a beaded spigot on the other for connection to nominal glass pipe dimensions DN40, DN50, DN80 & DN100.

Cat. No.	L451	L452	L453	L454
Nom. Size	38mm	51mm	76mm	102mm
A	28mm	32mm	41mm	36mm
gms	40	66	400	665
Product Code	V6045104	V6045204	V6045304	V6045404

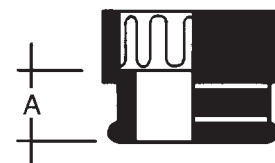

L801 Thermal Stress Relief Unit

Designed for use with 38mm diameter pipe, the L801 can be installed in either vertical or horizontal pipework. When installed it is important to ensure that the end with the moulded fixing clip is the outflow end of the fitting.

When installing a stress relief unit, the tail end pipe should be pushed fully 'home' and its position marked. It should then be withdrawn 38mm.

Cat. No.	L801
Nom. Size	38mm
A min	70mm
A max	108mm
Product Code	V6080101

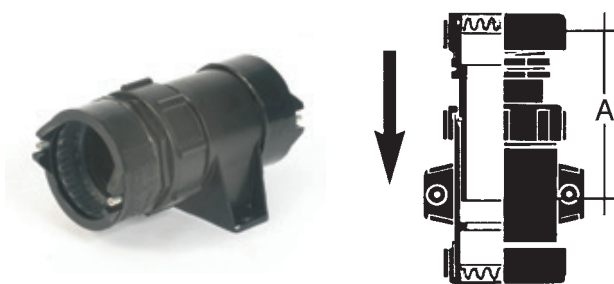

L802 Thermal Stress Relief Unit

Designed for use with 51mm diameter pipe, the L802 can be installed in either vertical or horizontal pipework. When installed it is important to ensure that the end which forms the collar is the outflow end of the fitting.

The unit must be anchored with a metal clamp which should be located round the body of the stress relief unit, just below the ridge round the top of the collar. This allows the pipe inserted into the collar to expand and contract.

Cat. No.	L802
Nom. Size	51mm
A min	149mm
A max	203mm
B	73mm
gms	750
Product Code	V6080201

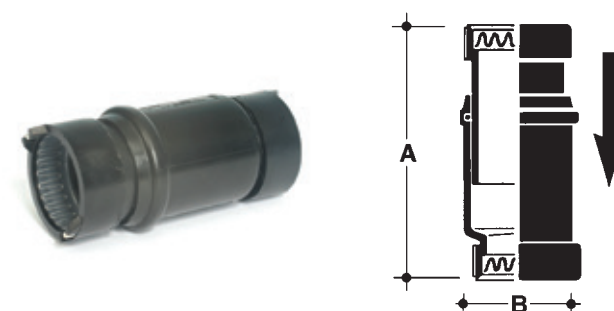

L803/4/6 Thermal Stress Relief Unit

Designed for use on 76mm, 102mm and 152mm diameter pipes this unit can be installed in either vertical or horizontal pipework. When installed it is important to ensure that the spigot end is on the outflow end of the fitting.

The unit must be anchored with a metal clamp which should be located on top of the moulded locators, moulded round the body of the stress relief unit, which then allows the pipe inserted into the collar to expand and contract. **Note:** The body of the SRU incorporates an 'O' ring seal.

Cat. No.	L803	L804	L806
Nom. Size	76mm	102mm	
A	198mm	215mm	198mm
B	117.2mm	144.5mm	200.5mm
C	110mm	141mm	196mm
D	101.7mm	129mm	184.5mm
E	89.7mm	115mm	169.5mm
gms	575	900	
Product Code	V1080301	V1080401	V6080601

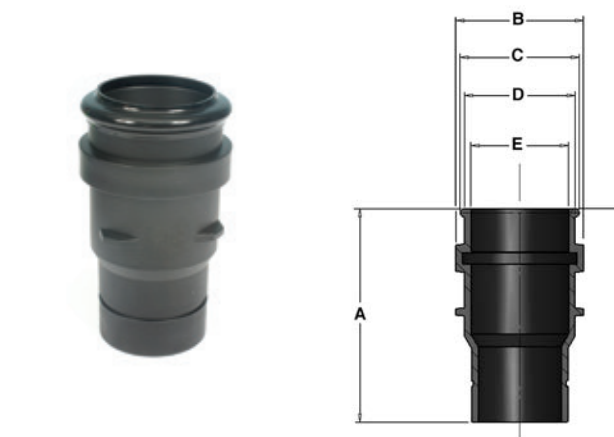

L902/3/4 Access Pipe

Correctly sited at critical points in the pipeline, access pipes simplify clearing blockages, inspection and thorough cleansing of the installation. With a clear flow bore, the L90 series has a bolt on cover and spigot ends for fusion to enfusion sockets.

Cat. No.	L902	L903	L904
Nom. Size	51mm	76mm	102mm
A	260mm	302mm	390mm
B	164.2mm	164.2mm	218.6mm
C	114.4mm	114.4mm	138.8mm
D	145mm	145mm	179mm
Product Code	V1090201	V1090301	V1090401

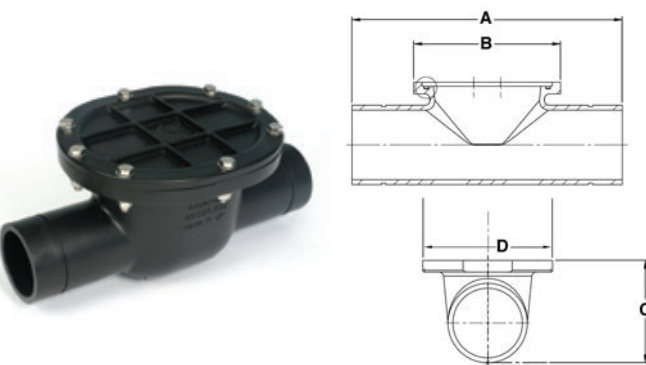

L40 Flange

To fit pipe sizes from 38mm to 152mm, the flange is supplied undrilled. Flanges should be clamped together with a nitrile gasket and 4 M20 bolts.

Cat. No.	L401	L402	L403	L404	L406
Nom. Size	38mm	51mm	76mm	102mm	152mm
A	98mm	114mm	146mm	178mm	235mm
B	127mm	150mm	189mm	228mm	278mm
C	16mm	18mm	23mm	28mm	25mm
D	14mm	17mm	17mm	17mm	17mm
gms	280	310	600	780	1768
Product Code (Undrilled)	V6040101	V6040201	V6040301	V6040401	V6040601

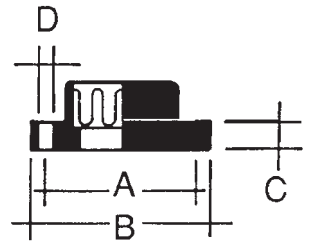

L24 Cleanout Plug

A simple method for draining or rodding a blocked section, the Cleanout is available to suit pipe sizes from 38mm to 102mm. The fitting comprises of a spigot which can be fused into an Enfusion socket and a threaded plug.

The A dimension shows the disassemble length with a clearance allowance of 13mm. Wrap PTFE tape around the thread of the plug to make a seal.

Cat. No.	L241	L242	L243	L244
Nom. Size	38mm	51mm	76mm	102mm
A	160mm	185mm	185mm	210mm
gms	140	150	280	480
Product Code	V6024101	V6024201	V6024301	V6024401

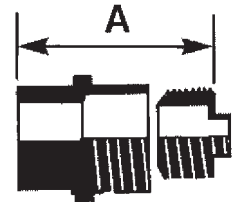

Note: For 152mm cleanout, use an L3946 reducer with an L244 cleanout plug.

L2610 Link Cable

Link cable leads in 1m lengths for multiple jointing.

Product Code C53EN003



L261 Clamp

Available in six sizes for 38mm to 152mm fittings, these stainless steel clamps should be fitted over the hubs of the Enfusion sockets and tightened before electrofusion welding.

		Product Code
Sizes:	38mm	V6261014
	51mm	V6261024
	76mm	V6261034
	102mm	V6261044
	152mm	V6261064



L2601 Enfusion Hand-held Unit

(See specification details on page 44)

Product Code V6ECU001



Pipe Scraper

Pipe should be thoroughly scraped over an area equal to socket depth plus 50% using a pipe scraper. Replacement blades (2 per packet) are supplied separately.

Product Code	C53MJ001	Pipe Scraper
	C53MJ002	Replacement Blades



Vulcathene Chemical Waste Drainage System

Enfusion Drainage Design

A typical laboratory bench waste run, incorporating drip cups discharging into bottle traps and then into a Vulcathene stack.

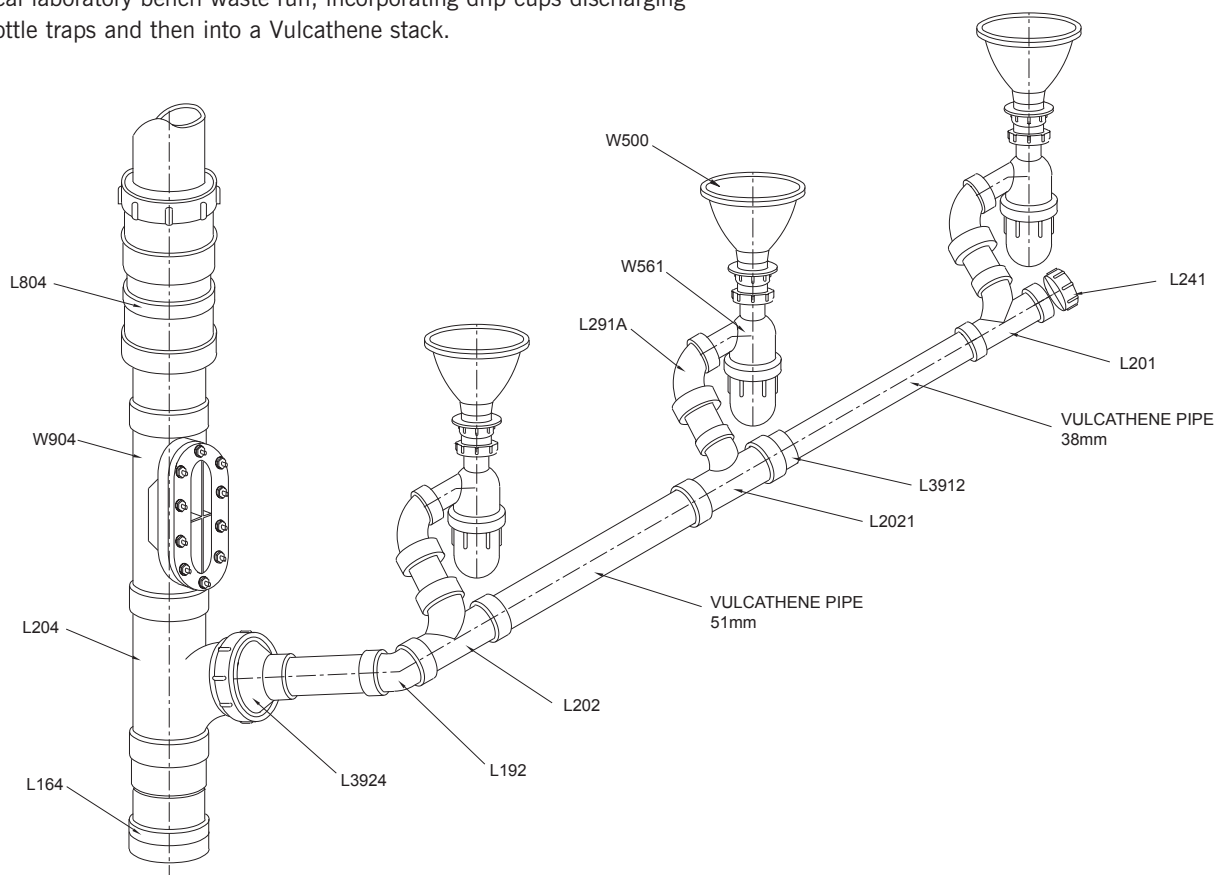

Making the Enfusion Joint

The Enfusion Joint

Enfusion fittings are manufactured with an integral resistance wire. The wire is electrically heated by means of a microprocessor controlled Enfusion Control Unit. This results in fusion and bonding of the pipe to the fitting. Jointing is achieved within minutes.

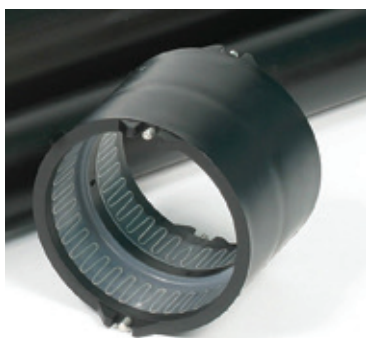

The Enfusion joint achieves the optimum level of performance where it matters most – at the joint interface.

Controlled fit, controlled temperature and controlled time. All of this is achieved by means of the Enfusion Control Unit, which ensures proper electrical connections, joint timing and input/output current levels. The combination of these features provides both simplicity of jointing and perfect control.



The integral resistance wire is manufactured from a heavy gauge nickel/chrome alloy which allows for uniform electrical resistance and heating, while offering excellent chemical resistance.

The overall result is a state-of-the-art jointing method which offers simplicity and quickness.

Making the Enfusion Joint

Before making the Enfusion Joint, it is important to check that the power source is providing 104 to 126 volts at 45 to 65 cycles with 16amp capacity. The Enfusion controller provides for reasonable and normal power variation, but generators in particular should be checked to ensure that rated output is being provided.

Preparation

1. Cut the pipe square and remove all burrs and loose material. *Use a tube cutter with a wheel designed for use on plastic pipe. If a saw and mitre box combination is used, make certain to remove all burrs. DO NOT CHAMFER THE CUT.*
2. Using a pipe scraper, scrape the end of the pipe equivalent to the depth of the socket plus 50%. *Removal of the slick or 'skin' on the surface of the pipe is imperative to obtain a good fusion joint. Once prepared DO NOT handle this area or allow it to get dirty.*



3. Insert the pipe all the way to the stop at the bottom of the socket.
4. Decide whether the joint will be welded singly or in series. *If multiple joints are to be made, refer to the table on the next page which indicates the maximum number of joints relative to the pipe size.*
5. Loosely fit the appropriate sized clamp(s) over the hub(s) of the socket(s) to be joined and position flush with the socket opening. It is imperative to ensure correct positioning of clamps.
6. Tighten the clamp(s) around the hub(s) of the socket(s). *It is important that the clamp(s) is/are tightened sufficiently to stop pipe rotation in the socket. Do not overtighten.*
7. Before using the Enfusion Control Unit ALL cables MUST be unwound from the protective frame or removed from the Pelicase if using the hand-held unit.
8. Turn the Enfusion Control Unit on and it will self-test. *Ensure the unit displays a copyright message.*

Vulcathene Chemical Waste Drainage System



9. Follow the instruction on the display to 'Connect Output Lead'.
If using a single joint, connect the output leads to one joint. If multiple joints, utilise the link leads as required.

Note: Terminal pin extension adaptors are available where access to the fitting terminal pin is restricted.

10. **Hand-held Unit:** Press START button to begin welding.
The Enfusion Control Unit will display the temperature and the welding time.
Old style Unit: Use select button & select 3" or above for all sizes; then press START button to begin welding.
11. When completed, the Enfusion Control Unit will emit an audible alarm and display the message 'Disconnect Output Lead'.
During this period the Enfusion Control Unit will count down to zero.
12. Wait 30 seconds to allow the joints to cool, before gently disconnecting leads from the joints.
The Enfusion Control Unit will now reset, ready for the next operation.
13. Leave the joint undisturbed for at least 5 minutes before removing clamp(s).

Troubleshooting

If the Enfusion Control Unit stops before joint completion, the unit will send an audible alarm and the fault display will show... Interrupted weld, or output fault, or connection fault.

If you discover the interruption in less than 2 minutes, correct the fault displayed and press the yellow 'SELECT' button to reset. The remaining weld time will be displayed. Press the green 'START' button to restart the weld.

If a joint has been at fault for more than 2 minutes the joint will have cooled. The full cycle therefore should be run again.

Prior to re-fusing, 38mm to 76mm fittings should cool for 5 minutes and 102mm to 152mm fittings should cool for 7 minutes.

The Enfusion Control Unit should be re-set by shutting it off and the following from Step 8 onwards.

Note: When working in very cold conditions try to screen the joint from direct contact with the wind. Protecting the joint with a 'blanket' will also help prevent excessive loss of heat due to a chill wind.

Making Multiple Enfusion Joints

The chart below indicates the number of joints which can be fused at any one time utilising additional link cables in series.

Note: If multiple jointing fittings of different sizes, the total joint internal diameter must not exceed 306mm.

Multiple Joint Fusion Chart

Pipe size	38mm	51mm	76mm	102mm	152mm
Maximum number of joints	8	6	4	3	2

Note: Important software update September 2015

Following changes to the Enfusion range of products in September 2015, all sizes of fittings from 38mm to 152mm are now welded at the same fusion time.

Hand-held Unit:

If your Hand-held unit has not been reprogrammed you should use the 3" to 12" size range selection for all sizes, including 1.5" & 2" (38mm & 51mm). For example, 1.5" (38mm) fittings should use the 3" to 12" selection.



Old style Enfusion Unit: (yellow box/blue cage): Old style Enfusion units cannot be reprogrammed. Until such time that a newer machine can be purchased (or hired) you should select the 3" to 12" size range selection for all sizes, including 1.5" & 2" (38mm & 51mm). The weld time for 3" to 12" sizes is the same.



Vulcathene Chemical Waste Drainage System

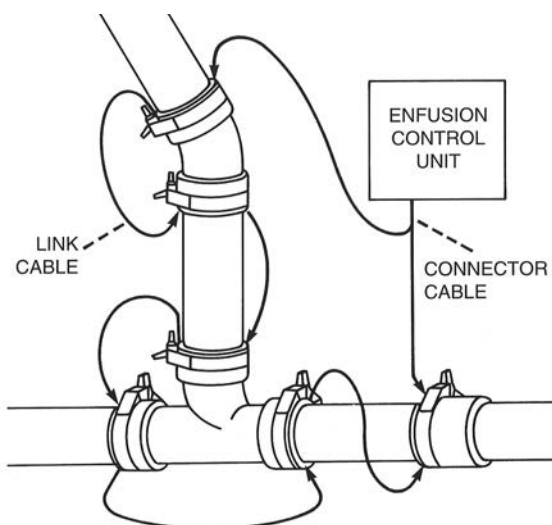

Typical Multiple Jointing Configuration

Enfusion Unit (Hand-held) Specification

Operating Mode	Enfusion automatic
Operating Language	English
Operating Temperature	-20°C to +50°C
Input Voltage	110 V ac 88 V to 149 V (-20% +35%)
Input Current	11 A
Input Frequency	50 Hz 40 Hz to 70 Hz
Input Power	100 VA to 1250 VA
Output Current	18 A ac true rms
Output Voltage	3 V to 50 V ac true rem
Output Power	50 W to 900 W
Output Stability	+/- 1.5%
Weld Time: 1.5" & 6"	C 150 : N 120 : H 110
Power Factor	0.72
Weight	15kg
Size	40cm x 32cm x 16cm
Environmental Protection	IP65
Lead Length (to power case)	1m
Lead Length (to hand-held unit)	10m
Lead Length (to fitting)	2m

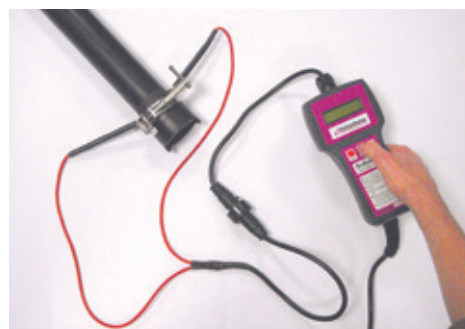

Enfusion Control Units contain sophisticated electronic components and should therefore be handled with care. Do not tamper with them and should they, for any reason, malfunction, please call our local Vulcathene distributor or representative.

Installation Advice

Waste Pipe Fall

Horizontal waste runs should be installed to provide a natural 'fall' to the Vulcathene stack. The fall is dictated to some extent by the installation. 2° to 3° is an ideal 'fall', but it should never be less than 1°.

Note: A waste system flows best at a fall of 2° to 3°, transporting any solids which may be flushed away, so the potential for blockages is reduced. Also, as chemicals will only be 'flowing' through the system, the possibility of long term chemical damage will be eliminated.

Typical Pipework Falls for Vulcathene Pipes

Pipe length	Fall in pipework at 1°	Fall in pipework at 2°	Fall in pipework at 2.5°	Fall in pipework at 3°
	Metres	Millimetres		
1.0	17.46	34.93	43.67	52.24
1.5	26.19	52.39	65.50	78.36
2.0	34.91	69.85	87.33	104.48
2.5	43.64	87.31	109.17	130.60
3.0	52.37	104.78	131.00	156.72
3.5	61.10	122.24	152.83	182.85
4.0	69.83	139.70	174.67	208.97
4.5	78.56	157.16	196.50	235.09
5.0	87.29	174.63	218.34	261.21
5.5	96.01	192.09	240.17	287.33
6.0	104.74	209.55	262.00	313.45
6.5	113.47	227.01	283.84	339.57
7.0	122.20	244.48	305.67	365.69
7.5	130.93	261.94	327.50	391.81
8.0	139.66	279.40	349.34	417.93
8.5	148.38	296.86	371.17	444.05
9.0	157.11	314.33	393.00	470.17
9.5	165.84	331.79	414.84	496.29
10.0	174.57	349.25	436.67	522.42
10.5	183.30	366.71	458.50	548.54
11.0	192.03	384.18	480.34	574.66
11.5	200.76	401.64	502.17	600.78
12.0	209.48	419.10	524.00	626.90

Vulcathene Chemical Waste Drainage System

Supporting Vulcathene Pipes

Vulcathene pipe does not typically require continuous support when used for horizontal runs at room temperatures. Vulcathene pipe clips should be fixed at the following recommended centres:

Nominal I.D.	38mm	51mm	76mm	102mm	152mm
Horizontal Fixing Centres	1.22m	1.37m	1.52m	1.83m	1.83m
Vertical Fixing Centres	1.5m	1.5m	1.5m	1.5m	1.5m

Vulcathene pipe clips are snap-on and retain the pipe securely whilst still allowing lateral movement of the pipe caused by fluctuations in thermal conditions.

- Note:** (i) When 76mm or 102mm pipe is installed in vertical runs of some length, strain may be caused by thermal movement. In such conditions metal straps should be used to retain the pipe.
- (ii) Horizontal pipe runs, where sustained temperatures in excess of 40°C (104°F) are expected, should have continuous support using Vulcathene galvanised support channel.
- (iii) Where Vulcathene pipework is to be suspended, metal hangers are recommended.

Buried Pipes

Generally, trenches should not be less than 1m deep. The trench should be straight sided and as narrow as possible to allow proper consolidation. The trench bottom should be level and free from rock, debris and sharp objects.

A 100mm deep bed of pea gravel should be laid in the bottom of the trench and backfilling, with similar material, should continue until a 100mm layer over the pipe is achieved.

Pipes may be jointed in the trench but if jointed above ground should be allowed to cool sufficiently.

Reducing Pipe Sizes

Apart from the 51mm x 38mm fitting which is produced as a one piece moulding, all reducing sweep tees in the Mechanical range are made by adding a W39 series reducing coupler to the branch of a W20 series equal sweep tee. Enfusion sweep tees are one piece moulded items.

Thermal Movement and Vulcathene Pipework

To overcome the problem of expansion and contraction from changing temperatures, Vulcathene Stress Relief Units (SRUs) eliminate the stresses and strains caused by thermal movement.

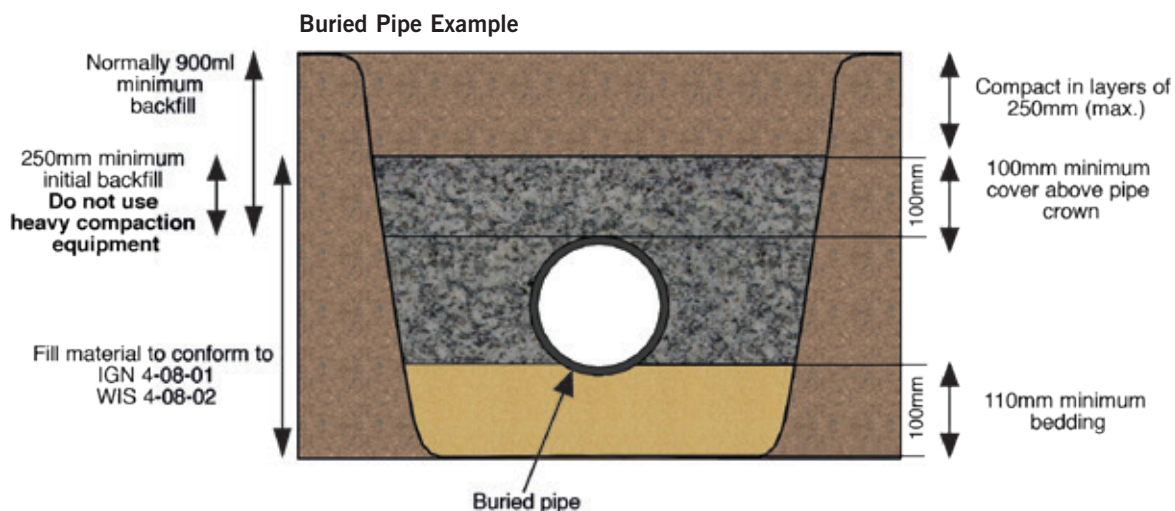

Vulcathene Chemical Waste Drainage System

When installing an SRU, care should be taken to ensure an accurate Linear 'thrust and pull' movement. Any pipe clip used should not grip the pipe tightly, but should allow the pipe to slide freely without any tendency to buckle. The housing of the SRU should always be firmly anchored to allow the sliding member to accept all movement.

Vulcathene SRUs move very easily at about 5psi, the total movement, for all sizes, being approximately +/- 25mm (1"). The co-efficient of expansion for Vulcathene plumbing is 1.4mm per metre per 10°C.

On Vulcathene stacks, an SRU should be installed at every floor level where there is a stack connection. If there is no stack connection one SRU should be installed every two floors.

SRUs can be installed on horizontal pipes where there are insufficient changes in direction to accommodate thermal movement, eg. on long runs or where hot water is being conveyed.

Installing Vulcathene Thermal Stress Relief Units

All Vulcathene thermal SRUs are directional to the flow of the liquid. On 38mm and 51mm SRUs the tail end pipe should be pushed fully home and its position marked. It should then be withdrawn 38mm.

The 76mm, 102mm & 152mm are spigot ended for either mechanical or electrofusion jointing and have an open chamber fitted with a dust cap. The dust cap is prised off and slid up the pipe; the pipe is chamfered, lubricated and then slid into the chamber of the SRU until it hits the stop. The pipe should then be marked to show the limit of travel, then withdrawn approx. 25-38mm. The dust cap is then firmly replaced.

Note: 76, 102 + 152mm SRU's have built-in O-Ring seals.

The body must be firmly held still to allow the SRU to function properly. SRUs should be anchored with a metal clamp except the 38mm which has a moulded fixing clip. Multiple fix points may be required where necessary.

System Testing

The system should be inspected for any possible leaks in accordance with BS EN 12056. Air should be pumped into the system through a branch of a tee piece until a pressure equal to 38mm water gauge is achieved. The inlet valve should then be closed and the system should maintain the pressure for a minimum of three minutes.

System Maintenance

The W561 and W571 anti-siphon bottle traps and the W681 anti-siphon dilution recovery traps have sumps that can be removed for cleaning by unscrewing. The chamber of the W691 anti-siphon dilution recovery trap is removed by unscrewing the flange assembly.

The W612 dilution recovery trap is cleaned by removing the dip tubes and carefully flushing the interior of the dilution chamber. The new 910G is supplied with a removable lid & gasket seal, both held in place by a stainless steel clamp which can be easily removed for access & maintenance. The W90/L90 series access pipes should be fitted into the pipework system as required to provide sufficient and suitable access for testing and maintenance.

Installing Sinks, Drip Cups and Waste Assemblies

When 504 wastes are used with a plastic or thin walled vessel a Butyl Rubber Gasket should be fitted between the backnut and underside of the sink. All sinks, drip cups and slotted waste assemblies should be bedded with a suitable sealant. eg. Dow Corning 786.

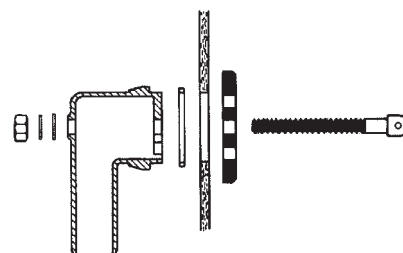

The illustration above shows a 509 overflow assembly with flexible hose to connect to the waste. The overflow bend and face-plate are set in with a suitable sealant. eg. Dow Corning 786.

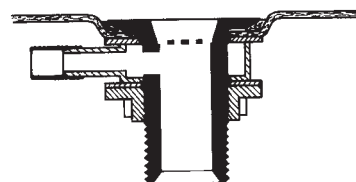

The illustration above shows the slotted version of the 504 waste assembly used in conjunction with the 509 overflow assembly. The waste, overflow collar and washer are all set with a suitable sealant. eg. Dow Corning 786.

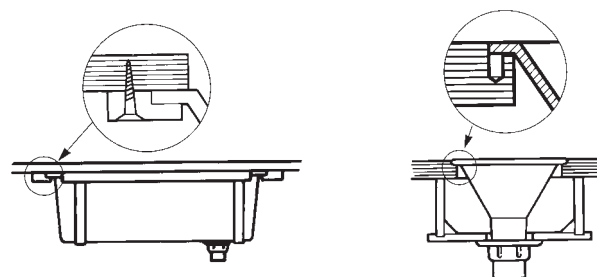

The illustrations above show the recommended method of supporting Vulcathene sinks using wooden battens screwed to the underside of the work top. Larger capacity sinks may need additional supporting metal straps in the manner shown. It is recommended that all Vulcathene Drip Cups are secured to the work top using a timber frame as illustrated above.



1. Position lower half of saddle around pipe.



2. Taking care to seat gasket in the branch outlet, bolt both halves together.



3. Use a spanner to tighten. Do not over torque!



4. Drill pipe wall.

Installing Clamp Saddles

Vulcathene clamp saddles enable fast and easy connection of new branch pipes to existing Vulcathene stacks without the need for special tools or equipment:

1. Position lower half of saddle onto pipe.
2. Taking care to seat the gasket seal in the branch outlet (and the anti-rotation insert into the lower part of the saddle), bolt both halves together.
3. Use a spanner to tighten; do not over-torque!
4. Drill pipe wall.

Clamp bolts should be tightened with care. Avoid overtightening. Tighten until the upper part is well compressed on the pipe & resistance to the nut screwing has become high. **Note:** 76mm saddles are supplied with 4 x bolts; 102mm saddles with 6 x bolts

Storage

The high impact strength of Vulcathene provides some protection against general handling damage on site. However certain precautions should be observed:

- a) The pipes should be stored on a level flat surface free from sharp stones and similar obstructions.
- b) Small pipes may be 'nested' inside larger pipes.
- c) The stack should be supported, or braced to prevent collapse.
- d) The pipes should not be stacked higher than:

Pipe Size	Max stacking height
Up to 76mm	20 x pipe size
102mm	12 x pipe size

- e) When stored in tropical countries for prolonged periods the pipes should be temporarily covered.
- f) Pipes in the stack should not be subject to excesses of temperature variation.

While it is not considered necessary for pipes installed in the UK, where pipes are to be installed in locations likely to be permanently exposed to prolonged periods of strong sunlight, such as in tropical countries, their life may be extended by painting. For more information please contact our Technical Support Department on +44 (0)1543 272445.

COSHH Regulations

Attention is drawn to the requirements of the Health and Safety at Work Act and COSHH Regulations. Durapipe UK cannot accept any responsibility for accidents arising from the misuse of its products, faulty installation and incorrect application. Copies of COSHH Regulations are available on request.

UniCollar® Fire Protection

1. Removing the Casing and Accessories from the Box

The box contains the fixings and accessories required to install the collar. Open the box at the position clearly marked with an arrow. Remove the box of accessories.

The end of the collar can now be pulled and the strip will uncoil. Ensure the soft Graftex faces up. The collar strip has snapping perforations at 15mm centres.

Only pull out enough strip for the collar length required.



2. Cutting and Snapping the Strip

Identify the outside diameter of the pipe that is to have the collar applied to. On the box is a table, which gives the number of segments for each size pipe and the length of strip required. Either count the number of (15mm) segments required or measure the strip. Cut through the Graftex at the appropriate position eg. for a 114mm OD pipe, cut at segment marked 30.

Hold the strip with a finger and thumb on each side of the cut and as close to the cut as possible, and fold in a downward direction as far as possible. Repeat this folding until the steel snaps.



3. Fixing the Collar

The ends of the Graftex, once cut, will be square. To make it easy to fix, cut these square ends away at a slight angle. Shape the strip to the approximate diameter of the pipe.

If the pipe is small (eg. under 75mm) pay extra attention to the ends of the strip to ensure they have been shaped correctly. Push one of the prongs of a bracket through the notch at one end of the strip. Fold the strip around the pipe and push the other prong through the notch on the other end of the strip. (The bracket can be gently hammered in to position if pushing is difficult). Attach the bracket to the wall or floor as described over and shown on the box drawings. Fix the other bracket(s) as required.

Ensure the correct number of brackets are always used and the 2 ends of the strip always have a connecting bracket.



Vulcathene Chemical Waste Drainage System



4. Floors

The UniCollar® achieves Fire Resistance Level (FRL) up to 4 hours with Vulcathene pipes up to 114mm diameter, bolted to soffit of floor slab (with a similar fire rating or the same of greater thickness) using the 20mm x 5mm steel anchors provided, through the holes in the brackets provided. The concrete must be in a condition that will ensure the anchors hold securely. Larger steel fixings may be used if deemed appropriate. Back fill any gap between the pipe and concrete greater than 8mm with mortar or commercial grade mortar mix. Acrylic, intumescent or silicone sealant may be applied around the pipe on the topside of the floor slab if a water seal is required. If there is a possibility of pipe movement occurring that will cause cracks in the seal between the pipe and mortar mix (if used), it may be advisable to seal the pipe with acrylic, intumescent or silicone sealant to prevent cold smoke egress. This however is not required for the fire rating to be achieved. If the gap between the pipe and slab is less than 8mm, apply a bead of acrylic, intumescent or silicone sealant approx. 8mm deep in to the gap at the soffit.

Fire Resistance (BS 476: Part 20)

<u>Pipe Size</u>	<u>Integrity</u>
38mm-102mm	4 hours
*152mm	2 hours

***Note:** 2 UniCollars® are required on 152mm size pipe.

5. Walls

For framed walls, use the 40mm x 10 laminating screws provided. For masonry walls, use the 20mm x 5mm steel anchors provided. The wall or floor must be in a condition that will ensure the anchors hold securely. Larger steel fixings may be used if deemed appropriate. Ensure the annular gap between the wall and pipe is minimal and seal this gap with a bead of acrylic, intumescent or silicone sealant. Attach a collar to both faces of the wall. Fire tests were conducted with 2 brackets on pipes 69mm and under. For framed walls, 3 brackets are recommended if framing studs are not available to screw in to.

Fire Resistance (BS 476: Part 20)

<u>Pipe Size</u>	<u>Integrity</u>
38mm-152mm	2 hours

For details of suitability and approvals for use of UniCollar® for other pipe materials and sizes contact the Technical Support Department on +44 (0)1543 272445.

Pipe Diameter (mm)	No. of Collars per Carton
38	8
51	7
76	6
102	5
152	3

Vulcathene Chemical Waste Drainage System

Connection to other Pipework

Vulcathene Mechanical/Enfusion

Vulcathene Enfusion and Mechanical are fully compatible offering total versatility to the designer/installer of chemical waste drainage systems.

Vulcathene Polyfusion

Vulcathene's original and first thermoplastic pipework system for chemical waste has been replaced by Vulcathene Enfusion, for installations where a welded drainage system is preferred.

To connect Polyfusion to Mechanical

A W271 1³/₄" F.I. pipe coupler should be used when joining 38mm Vulcathene Mechanical pipe to 38mm Vulcathene Polyfusion pipe. The F.I. thread of a W271 can be screwed to the M.I. thread of a Polyfusion C130 38mm half coupler which is then socket fused to Polyfusion pipe.

The W271 may also be screwed to the outlet of any Vulcathene Polyfusion trap to provide a connection for 38mm Vulcathene Mechanical pipe.

Polyfusion pipe sizes 51mm-102mm should be treated as Mechanical, i.e. groove the pipe, place an olive in the groove, lubricate the fitting thread and tighten the nut.

To connect Polyfusion to Enfusion:

Use Vulcathene BS Table D flanges. Polyfusion and Enfusion cannot be jointed together using socket or electrofusion jointing methods due to the incompatibility of the materials used.

Other Plastic and Metal Materials

W14, W15, L14 and L15 range of pipe couplers have standard BSP parallel threads and can be screwed directly to the M.I. and F.I. ends of metal or plastic pipes.

Where a BSP connection is not possible, use Vulcathene BS Table D flanges.

Borosilicate Glass

Vulcathene to glass adaptors are available from 38mm to 102mm.

Cast Iron

Use Vulcathene BS Table D Flanges.

Stoneware

When it is intended to insert Vulcathene pipe directly into a collar or socket of another material the following procedure should be adopted. Roughen or score the pipe end with a suitable tool - a coarse file - to provide a suitable 'key'. Pack the socket half full with rope and follow by caulking with acid-resistant cement or a proprietary brand of sealing compound until level with the bead of the collar.

Flexible Couplers and Adaptors

Flexible couplers and adaptors can be used to connect Vulcathene to other pipe materials.



W16
Line Coupler



L16
Line Coupler



L36
Enfusion Flange



W100
BS Table D Flange



W271
1³/₄" F.I. to Pipe Coupler



C130
Half Coupler



W14
BSP Coupler



W15
BSP Coupler



W45
Glass Adaptor



L45
Glass Adaptor



L14
BSP Coupler



L15
BSP Coupler



AC1221/1361
AC5144/1362
Flexible Adaptor Coupling



DC95/DC115
Flexible Drain Couplings

Connection to other Pipework

Vulcathene Polyfusion

Polyfusion, Vulcathene's first thermoplastic chemical waste system, manufactured from a low density polyethylene and jointed by socket fusion, is no longer manufactured although the Polyfusion fittings required to convert Polyfusion pipework to Vulcathene Mechanical or Vulcathene Enfusion are available.

The Polyfusion Joint

Socket fusion jointing involves the simultaneous heating of the outer surface of the pipe end and the inside surface of the socket of the fitting until a melt state is attained on each surface.

The pipe end is then inserted into the fitting, bringing the two melt surfaces into contact, such that they are subjected to radial pressure as a consequence of an interference condition between the melt surfaces. The two melt surfaces combine to produce a homogeneous joint upon cooling.

Making the Polyfusion Joint

1. The pipe end should always be cut square and burrs removed. Trimming is easily carried out with a sharp knife or small plane. Out-of-square pipe ends reduce the area of amalgamation and increase the possibility of misalignment between pipe and fitting in the finished joint.
2. Insert the pipe into the socket of the fitting and press fully home. Mark the tube along the outside shoulder of the socket.
3. Withdraw the tube from the socket. The mark will be the visual guide for the depth of pipe entry, first into the heated tool and then into the fitting socket.
4. The tool is heated to the required temperature using a gas torch. A thermal crayon should be used to confirm that the temperature is correct for socket fusion (approx. 240°C).
5. First, push the Polyfusion fitting fully onto the male side of the tool. Next, push the pipe into the female side. When the pipe is fully inserted, hold in place for a few seconds, as per the table below, (eg. 4 seconds for size 1 1/2")

Size of Fitting	Socket Time	Pipe time	Total time
1 1/2"	10 (6+4)	4	10
2"	14 (9+5)	5	14
3"	23 (15+8)	8	23
4"	40 (25+15)	15	40
6"	50 (30+20)	20	50

(Time indications are in seconds)

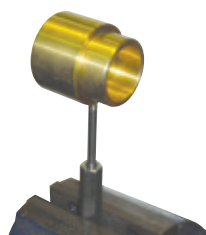

Hand tool held in vice for heating.

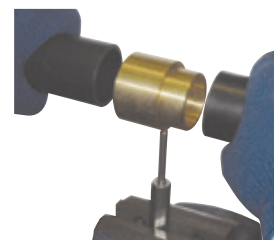

Pipe & fitting offered up to heated hand tool prior to jointing.

6. Extract the pipe and socket simultaneously from the tool, and having quickly ensured that a complete all round melt has been achieved enter the pipe into the socket.

Press the pipe into the socket up to, but no further than, the visual guide previously marked on the pipe. Align tube and fitting quickly and hold in position for a further few seconds whilst the molten surfaces solidify.

Vulcathene Polyfusion - Safety Guidance for site operation

Note: this method of jointing is only used for connection onto existing pipework systems, not on new installations.

Vulcathene Polyfusion tools in sizes 32 to 51mm are typically heated to the required temperature by means of a blow torch/ flame – care needs to be taken when using a naked flame.

To achieve a successful joint, the brass tool will be heated to approx. 300°C. The equipment must always be sited in a location which will prevent accidental bodily contact with the equipment. Where possible the heater plate, or fusion tooling, should be kept in a heat-proof bag between joints.

After each joint the excess material should be removed from the tool. During this operation protective gloves must be worn. Avoid skin contact with molten material at all times after removal from tool etc.

During the jointing, process fumes will be given off from the pipe and fitting. While the fumes are non-toxic they can be unpleasantly pungent and all working areas should be well ventilated.

When jointing out of doors or in well-ventilated areas, the risk from the fumes is very low

Converting Polyfusion to Mechanical

1½" Polyfusion pipe (nominal outside diameter of 44.4mm) to
1½" Mechanical pipe (nominal outside diameter of 48.3mm)

Fittings required:

C130 1½" Half Coupler
W271 1¾" F.I. Pipe Coupler

Joining procedure (See Figure 1):

1. Socket fuse the C130 Half Coupler and 1½" Polyfusion pipe using a 1½" Polyfusion Hand Tool
2. Apply PTFE tape to the thread of the C130 Half Coupler and screw the W271 1¾" F.I. Pipe Coupler to it until tight
3. Make a Mechanical joint from the W271 Coupler to Vulcathene Mechanical pipe

Alternative Procedure

Fittings required:

P758 1½" BSP Coupler

Joining procedure:

1. Socket fuse the P758 Coupler and 1½" Polyfusion pipe using a 1½" Polyfusion Hand Tool
2. Apply PTFE tape to the thread of the BSP Male Coupler and screw to W151 or L151 Female BSP Adaptor until tight
3. Make a Mechanical or Enfusion joint from BSP Adaptor to pipe

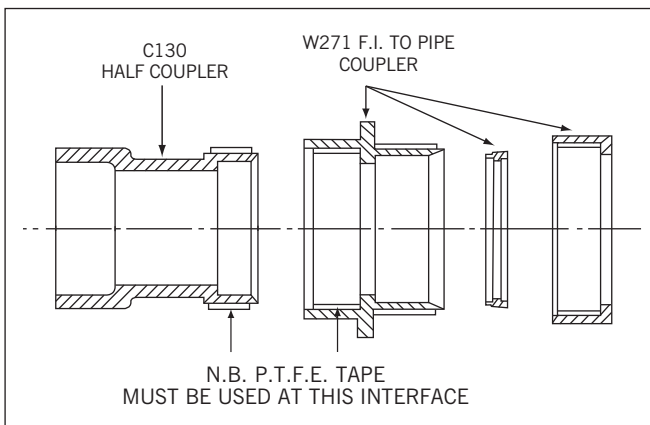

Figure 1.

Introduction

Information in the accompanying tables show the effect on Vulcathene of a wide range of chemicals. These results have been obtained from laboratory tests and when assessing them it should be remembered that unadulterated samples were used. In a typical chemical waste drainage application, however, water and other innocuous fluids would be discharged into the system to have a dilutionary effect on any noxious material that may be present.

If in any doubt about the action of any chemicals on Vulcathene or there is the possibility that Vulcathene is to be used in situations where specialised or unusual chemicals are involved, please contact our Technical Services Department.

The tables are intended to serve only as a guide and no guarantees can be given in respect of the data shown, which is based upon information available at the time of printing. Durapipe UK reserves the right to make any modifications deemed necessary by the acquisition of new data.

Classification

- Resistant
- Likely to be resistant
- Not resistant
- No data available

Vulcathene is classed * Likely to be resistant on the basis of the way the material behaves with chemicals of the same family group and where extensive usage by Vulcathene customers indicates suitability.

Vulcathene is classed - Not resistant on the basis of unadulterated test samples. In practice, the routine disposal of a wide variety of hot and cold chemicals is accompanied by appropriate amounts of water for the purpose of dilution and flushing.

Where no data is available, but where details or samples of chemicals can be supplied, Durapipe UK will conduct chemical suitability tests and make recommendations accordingly.

The following notes should be read in conjunction with the chemical resistance tables:

- These are compounds whose general formula is either $(R1)_2SO_4(R2)_2(SO_4)_6 \cdot 24 H_2O$ or $(R1)(R2)(SO_4)_2 \cdot 12 H_2O$, where R1 represents an atom of Potassium, Sodium, Ammonium, Rubidium, Caesium, Silver or Thallium; and (R2) represents an atom of Aluminium, Iron, Chromium, Manganese or Thallium.
- This substance is insoluble in pure water. If conveyed aqueous it would always be in the form of a suspension.
- This substance decomposes in hot water. Unless suitability is indicated refer to Durapipe UK.
- Substances which are generally categorised can have widely variable compositions, and therefore each needs to be tested for suitability. Refer to Durapipe UK.
- This substance is only sparingly soluble in water. If conveyed aqueous it would usually be in the form of a suspension.
- This substance is sparingly soluble in water, which then reacts with it.
- A solution of Chromium trioxide in water, often produced by the action of concentrated Sulphuric acid on Sodium dichromate.

Radioactive Waste

A well-established application for Vulcathene is low level radioactive waste solutions, e.g. in hospitals & research laboratories. To discuss specific requirements please contact our Technical Support Department on +44(0)1543 272445.

COSHH Regulations

Attention is drawn to the requirements of the Health & Safety at Work Act and COSHH regulations. Durapipe UK cannot accept any responsibility for accidents arising from the misuse of its products, faulty installation and incorrect application. Copies of COSHH Regulations are available on request.

Substance	Formula	Concentration	Chemical Resistance of Vulcathene		
			20 °C	60 °C	80 °C
Acetaldehyde, aqueous		40%	+	+	
Acetamide, aqueous	CH ₃ .CONH ₂		+	+	
Acetic acid	CH ₃ .COOH	100%	+		-
Acetic acid, aqueous		70%	+	+	+
Acetic anhydride	(CH ₃ CO) ₂ O	techn. grade	+		-
Acetone	(CH ₃) ₂ CO	techn. grade	+	+	
Acetophenone	C ₆ H ₅ CO ₂ CH ₃	techn. grade	+		
Acrylonitrile	CH ₂ :CH ₂ CN	techn. grade	+		
Adipic acid, aqueous	(CH ₂ CH ₂ C.COOH) ₂	saturated	+	+	+
Air			+	+	+
Ally alcohol (2-Propenol-1)	CH ₂ CH:CH ₂ OH	96%	+	+	
Aluminium chloride, aqueous	AlCl ₃ .AlCl ₃ .6H ₂ O	any	+	+	+
Aluminium chloride, solid			+	+	
Aluminium fluoride	AlF ₃ .AlF ₃ .H ₂ O AlF ₃ .3 ¹ / ₂ H ₂ O	conc.	+	+	+
Aluminium hydroxide (See Note 2)	Al(OH) ₃		+	+	
Aluminium metaphosphate	Al (PO ₃) ₃		+	+	+
Aluminium sulphate, aqueous	Al ₂ (SO ₄) ₃ , Al ₂ (SO ₄) ₃ . 18 H ₂ O	saturated	+	+	+
Aluminium sulphate, solid			+	+	
Alum, aqueous (See Note 1)		any	+	+	+
Amino acids			+	+	+
2-Aminoethanol (Ethanolamine)	H ₂ NCH ₂ CH ₂ OH	techn. grade	+		
Ammonia, aqueous	NH ₃	any	+	+	
Ammonia, gaseous			+	+	
Ammonia, liquid			+		
Ammonia water		any	+	+	
Ammonium acetate, aqueous	CH ₃ CO ₂ NH ₄	any	+	+	+
Ammonium carbonate, aqueous (See Note 3)	NH ₄ HCO ₃ .NH ₂ COONH ₄ .H ₂ NCOONH ₄	any	+	+	+
Ammonium chloride, aqueous (See Note 3)	NH ₄ Cl	any	+	+	+
Ammonium fluoride, aqueous (See Note 3)	NH ₄ F	saturated	+	+	
Ammonium hydrogen carbonate, aqueous	NH ₄ HCO ₃	saturated	+	+	
Ammonium hydrosulphide, aqueous	NH ₄ HS	any	+	+	
Ammonium nitrate, aqueous	NH ₄ NO ₃	any	+	+	+
Ammonium phosphate(s)	NH ₄ H ₂ PO ₄ .(NH ₄) ₂ HPO ₄ .(NH ₄) ₃ PO ₄ .3H ₂ O	any	+	+	+
Ammonium sulphate, aqueous	(NH ₄) ₂ SO ₄	any	+	+	+
Ammonium sulphide, aqueous	(NH ₄) ₂ S	any	+	+	+
Ammonium thiocyanate	NH ₄ SCN			-	-
Amyl acetate	CH ₃ .COO.(CH ₂) ₄ .CH ₃ , Pentyl acetate	techn. grade		-	-
Amyl alcohol (C ₅ alcohols)	CH ₃ .(CH ₂) ₃ .CH ₂ OH, Pentan-1-ol, Butyl carbinol	tech. grade	+	+	+
Aniline	C ₆ H ₅ NH ₂	any	+	+	
Aniline hydrochloride, aqueous	C ₆ H ₅ NH ₂ .HCl	any	+	+	
Animal oils			+		
Anon (Cyclohexanone)	CH ₂ .(CH ₂) ₄ .CO		+		
Anthraquinone sulphonic acid, aqueous (susp.)	C ₆ H ₄ (CO ₂)C ₆ H ₄ SO ₃ H		+		
Antifreeze (automotive) (See Note 4)		as supplied commercially			
Antimony chloride, anhydrous	SbCl ₃		+	+	
Antimony pentachloride	SbCl ₅		+	+	
Antimony trichloride	SbCl ₃ , Antimony (III) chloride, Butter of Antimony		+	+	
Aqua regia	(HCl + HNO ₃)		-	-	

Classification: + = Resistant * = Likely to be resistant - = Not resistant □ = No data available

Substance	Formula	Concentration	Chemical Resistance of Vulcathene		
			20 °C	60 °C	80 °C
Aromatic oils			-	-	
Arsenic acid, aqueous	HA ₅ O ₃	any	+	+	
Arsenic acid anhydride			+	+	
Ascorbic acid			+	+	
Asphalt			+		
®Asprin			+		
Barium hydroxide, aqueous	Ba(OH) ₂ ·8H ₂ O	any	+	+	+
Battery acid	conc. H ₂ SO ₄ diluted with water to about 25%		+	+	
Beater glue (animal glue)		as supplied	+	+	
Beef tallow			+	+	
Beer		+	+		
Beer sugar colouring		as supplied commercially	+	+	
Beeswax			+		
Benzaldehyde, aqueous	C ₆ H ₅ .CHO	any	+		
Benzene	C ₆ H ₆	techn. grade	-	-	
Benzene sulphonic acid	C ₆ H ₅ SO ₃ H		+	+	
Benzoic acid, aqueous	C ₆ H ₅ CO ₂ H		+	+	+
Benzyl alcohol	C ₆ H ₅ .CH ₂ OH		+	+	
Benzyl chloride	C ₆ H ₅ .CH ₂ Cl		-	-	-
Bichromate - sulphuric acid		conc.	-	-	-
Bismuth salts			+		
Bisulphite liquor			+	+	
Bitumen			+		
Bleaching solution containing 12.5% active chlorine**			-	-	-
Bone oil			+	+	
Borax (Sodium tetraborate), aqueous	Na ₂ B ₄ O ₇ , Na ₂ B ₄ O ₇ ·10H ₂ O, di-Sodium tetraborate	saturated	+	+	+
Boric acid, aqueous	H ₃ BO ₃	any	+	+	+
Brandy			+	+	
Bromic acid	Hbr	conc.	-	-	-
Bromine, liquid	Br ₂	100%	-	-	-
Bromine vapours			-	-	-
Butanediol, aqueous	HO(CH ₂) ₄ OH	any	+	+	+
Butanetriol, aqueous	HOCH ₂ CH ₂ CH(OH)CH ₂ OH	any	+	+	
Butanol, aqueous	CH ₃ (CH ₂) ₃ OH	any	+		
Butanone	C ₂ H ₅ COCH ₃		+		
2-Butenediol-1.4	HOCH ₂ CH=CHCH ₂ OH	techn. grade	+	+	
2-Butynediol-1.4	HOCH ₂ C≡CCH ₂ OH	techn. grade	+		
®Butoxyl (Metoxybutylacetate)	CH ₃ COO(CH ₂) ₄ OCH ₃		+		
Butter			+	+	
Butylene glycol	HO(CH ₂) ₄ OH	techn. grade	+		
Butyl acetate	CH ₃ .COO.(CH ₂) ₃ .CH ₃		*	-	-
Butyl acrylate	H ₂ C=CHCO ₂ (CH ₂) ₃ CH ₃		+		
Butyl alcohol	CH ₃ .(CH ₂) ₃ OH, Buton-1-ol		+		
Butyl phenol	C ₂ H ₅ CH(CH ₃)C ₆ H ₄ OH	techn. grade	+		
Butyl phenone	C ₆ H ₅ O(CH ₂) ₄ CH ₃	techn. grade	-	-	-
Butyl phthalate (Dibutyl phthalate)	C ₆ H ₄ O(COOC ₄ H ₉) ₂	techn. grade	+		
Butyric acid, aqueous	CH ₃ .CH ₂ .CH ₂ .COOH,	any	+		
Calcium carbide	CaC ₂		+	+	
Calcium carbonate (See Note 5)	CaCO ₃		+	+	+
Calcium chlorate, aqueous	Ca(ClO ₃) ₂	saturated	+	+	
Calcium chloride, aqueous	CaCl ₂ .CaCl ₂ ·2H ₂ O,CaCl ₂ ·6H ₂ O	saturated	+	+	+
Calcium hydroxide (See Note 5)	Ca(OH) ₂		+	+	+

Classification: + = Resistant * = Likely to be resistant - = Not resistant □ = No data available

Substance	Formula	Concentration	Chemical Resistance of Vulcathene		
			20 °C	60 °C	80 °C
Calcium hypochlorite, aqueous (suspension)	Ca(OCl) ₂		*	*	-
Calcium nitrate, aqueous	Ca(NO ₃) ₂ , Ca(NO ₃) ₂ ·4H ₂ O	50%	+	+	+
Calcium oxide (powder) (See Note 6)	CaO		+	+	
Calcium sulphate (See Note 5)	CaSO ₄ , CaSO ₄ ·2H ₂ O (Gypsum), CaSO ₄ · ¹ / ₂ H ₂ O (Plaster of Paris)		+	+	+
Camphor oil		any	-	-	-
Cane sugar, aqueous		any	+	+	
Carbazole	(C ₆ H ₄) ₂ NH		+	+	
Carbolic acid (Phenol)	C ₆ H ₅ OH		+		
Carbonic acid, aqueous	H ₂ CO ₃	any	+	+	
Carbonic acid, dry		100%	+	+	
Carbon dioxide	CO ₂	100%	+	+	
Carbon monoxide, gaseous	CO	techn. grade	+	+	
Castor oil			+	+	
Caustic soda solution	NaOH,	any	+	+	+
Cetyl alcohol (Hexadecanol)	CH ₃ (CH ₂) ₁₅ OH		+		
Chloral (Trichloroacetaldehyde)	CCl ₃ CHO	techn. grade	+	+	
Chloramine, aqueous	NH ₂ Cl	saturated	+		
Chloric acid, aqueous	HClO ₃	10%	+		-
Chloric acid, aqueous		20%	+	-	-
Chlorinated lime			+	+	
Chlorine, aqueous solution (chlorine water)	Cl ₂ + H ₂ O	saturated	*	-	-
Chlorine, gaseous, dry			-	-	-
Chlorine, gaseous, moist			-	-	-
Chlorine, liquid			-	-	-
Chlorine bleaching solution with 12.5% active chlorine			-	-	-
Chloroacetic acid, aqueous	ClCH ₂ CO ₂ H	<85%	+	+	
Chlorobenzene	C ₆ H ₅ Cl		-	-	-
Chloroform	CHCl ₃	techn. grade	-	-	-
Chloromethyl bromide	CH ₂ ClBr		-	-	-
Chlorosulphonic acid	ClSO ₃ H	techn. grade	-	-	-
Chrome alum (Potassium chromic sulphate) aqueous		saturated	+	+	+
Chrome anode slime			+		
Chromic acid, aqueous (See Note 7)		50%	-	-	-
Chromium trioxide, aqueous	CrO ₃	50%	-	-	-
Chromosulphuric acid			-	-	-
Cider			+	+	+
Citric acid, aqueous	C(OH)(COOH)(CH ₂ COOH) ₂ ·H ₂ O	saturated	+	+	+
Citrus juices			+	+	
Coal tar oil			-	-	-
Coconut oil			+		
Coconut oil alcohol		techn. grade	+		
Cod liver oil			+		
Coffee extract			+	+	
Cognac			+		
Cola concentrates			+	+	
Common salt, aqueous	NaCl	any	+	+	+
Copper chloride, aqueous	CuCl, CuCl ₂ , CuCl ₂ ·2H ₂ O	saturated	+	+	+
Copper cyanide, aqueous	Cu CN ₂	saturated	+	+	
Copper fluoride, aqueous	Cu F ₂	saturated	+		
Copper nitrate, aqueous	Cu(NO ₃) ₂ ·3H ₂ O, Cupric nitrate	30%	+	+	
Copper sulphate, aqueous	CuSO ₄ , CuSO ₄ ·5H ₂ O, Cupric sulphate	any	+	+	+

Classification: + = Resistant * = Likely to be resistant - = Not resistant □ = No data available

Substance	Formula	Concentration	Chemical Resistance of Vulcathene		
			20 °C	60 °C	80 °C
Corn oil			+	+	
Cottonseed oil		techn. grade	+	+	
Coumarone resins			+		
Creosote			*		
Cresol	CH ₃ (C ₆ H ₄)OH	100%	+		
Cresol, aqueous	Isomers of CH ₃ .C ₆ H ₄ .OH, Cresylic acid	dilute	+		
Crotonaldehyde	CH ₃ CH=CHCHO	techn. grade	+		
Cyclanone (fatty alcohol sulphonate)		as supplied commercially	+	+	
Cyclohexanol	CH ₂ .(CH ₂) ₄ .CH.OH		+	+	
Cyclohexanone (Anon)	CH ₂ .(CH ₂) ₄ .CO		+		
Decahydronaphthalene (®Dekalin)	C ₁₀ H ₁₈	techn. grade	-	-	
Detergents			+	+	
Developer solutions (photographic)			+	+	
Dextrin (starch gum), aqueous		18%	+	+	+
Dextrose, aqueous	O(CH.OH) ₄ .CH.CH ₂ OH, D-Glucose	any	+	+	+
1,2-Diaminoethane (Ethylenediamine)	H ₂ NCH ₂ CH ₂ NH ₂	techn. grade	+	+	
1,2-Dibromoethane	BrCH ₂ CH ₂ Br		-	-	-
Dibutyl ether	[CH ₃ (CH ₂) ₃]O		-	-	-
Dibutyl phthalate (Butyl phthalate)	C ₆ H ₄ (COOC ₄ H ₉) ₂	techn. grade	+		
Dibutyl sebacate	CH ₃ (CH ₂) ₃ O ₂ C(CH ₂) ₈ CO ₂ (CH ₂) ₃ CH ₃		+		
Dichloroacetic acid	Cl ₂ CHCOOH	techn. grade	+		
Dichloroacetic acid methyl ester	Cl ₂ CHCO ₂ CH ₃		-	-	-
Dichlorobenzene	C ₆ H ₄ Cl ₂		-	-	-
Dichlorodiphenyltrichloroethane (DDT, powder)			+	+	
Diethanolamine	[CH ₂ (OH).CH ₂] ₂ NH	techn. grade	+		
Diethylene glycol	(HOCH ₂ CH ₂) ₂ O		+	+	
Diethyl ether	(C ₂ H ₅) ₂ O		-	-	-
Diglycolic acid, aqueous	O(CH ₂ CO ₂ H) ₂	30%	+	+	
Dihexyl phthalate	C ₆ H ₄ (COOC ₆ H ₁₁) ₂	techn. grade	+		
Diisobutylketone	[(CH ₃) ₂ CH.CH ₂] ₂ CO	techn. grade	+	-	-
Diisooctyl phthalate	C ₆ H ₄ (COOC ₈ H ₁₇) ₂	techn. grade	+		
Dimethylamine	(CH ₃) ₂ NH		+		
Dimethyl formamide	H.Co.N(CH ₃) ₂ , DMF, N. N-Dimethylformamide	techn. grade	+	+	
Dinonyl phthalate (DNP)	C ₆ H ₄ (COOC ₉ H ₁₉) ₂	techn. grade	+		
Diocetyl phthalate	C ₆ H ₄ [COO.CH ₂ .CH(C ₂ H ₅)(CH ₂) ₃ CH ₃] ₂ , Di-(2-ethylhexyl) phthalate, DOP		+		
Disodium phosphate	Na ₂ HPO ₄		+	+	+
Disodium sulphate	Na ₂ SO ₄		+	+	+
Dodecylbenzenesulphonic acid	C ₁₂ H ₂₅ C ₆ H ₄ SO ₃ H		+		
Drinking water, also chlorinated	H ₂ O		+	+	+
Emulsions (photographic)			+	+	
Epichlorohydrin	ClCH ₂ (CH ₂) ₂ O		+		
Ethanolamine (2-Aminoethanol)	H ₂ NCH ₂ CH ₂ OH	techn. grade	+		
Ethanol	CH ₃ CH ₂ OH	96%	+	+	+
Ether, Diethyl ether	(C ₂ H ₅) ₂ O		-	-	-
Ethylenediamine tetraacetic acid	[CH ₂ .N(CH ₂ .COOH) ₂] ₂		+	+	+
Ethylene chlorohydrin (Chloroethanol)	ClCH ₂ CH ₂ OH	techn. grade	+		
Ethylene diamine (1,2-Diaminoethane)	H ₂ NCH ₂ CH ₂ NH ₂	techn. grade	+	+	
Ethylene dichloride (Dichloroethane)	ClCH ₂ CH ₂ Cl		-	-	-
Ethylene glycol	CH ₂ (OH).CH ₂ OH		+	+	+

Classification: + = Resistant * = Likely to be resistant - = Not resistant □ = No data available

Substance	Formula	Concentration	Chemical Resistance of Vulcathene		
			20 °C	60 °C	80 °C
Ethylene glycol monobutyl ether	HOCH ₂ CH ₂ OC ₄ H ₉	techn. grade	+		
Ethylene oxide, gaseous	CH ₂ .CH ₂ O		+		
Ethyl acetate	CH ₃ .COO.C ₂ H ₅	techn. grade	+		
Ethyl alcohol	C ₂ H ₅ OH	techn. grade	+	+	+
Ethyl alcohol + Avetic acid (fermentation mixture)		as used in brewing	+	+	
Ethyl benzene	C ₆ H ₅ CH ₂ CH ₃	techn. grade	-	-	-
Ethyl chloride	C ₂ H ₅ Cl	techn. grade	-	-	-
Ethyl chloride (Chloroethane)	CH ₃ CH ₂ Cl	techn. grade	-	-	-
Ethyl ether	(C ₂ H ₅) ₂ O	techn. grade	-	-	-
Ethyl ether (Diethyl ether)	(C ₂ H ₅) ₂ O		-	-	-
Fatty acids			+	+	
Fatty acid amides			+		
Fatty alcohols			+		
Ferric ammonium sulphate, aqueous	NH ₄ Fe(SO ₄) ₂ . 12H ₂ O	saturated	+	+	+
Ferric chloride	FeCl ₃ . FeCl ₃ .6H ₂ O, Iron (III) chloride	saturated	+	+	+
Ferric nitrate, aqueous	Fe(NO ₃) ₃ .9H ₂ O, Iron (III) nitrate	saturated	+	+	+
Ferric sulphate, aqueous (See Note 3)	Fe ₂ (SO ₄) ₃ , Fe ₂ (SO ₄) ₃ .xH ₂ O,				
	Iron (III) sulphate	saturated	+	+	+
Ferrous chloride, aqueous	FeCl ₂ .4H ₂ O	saturated	+	+	+
Ferrous sulphate, aqueous	FeSO ₄ .7H ₂ O	saturated	+	+	+
Fertilizer salts, aqueous		any	+	+	
Fluorine, gaseous	F ₂		-	-	-
Formaldehyde, aqueous	HCHO	up to 40%	+	+	
Formamide	HCONH ₂		+	+	
Formic acid, aqueous	H.COOH	10%	+	+	
Formic acid, aqueous		85%	+		
Fructose	O.CH ₂ .(CH.OH) ₃ .C(OH).CH ₂ OH, Laevulose		+	+	+
Fruit juices		any	+	+	+
Fruit juices, fermented			+	+	+
Fruit pulp			+	+	+
Fuming sulphuric acid	(H ₂ SO ₄ + SO ₃)	any	-	-	-
Furfuryl alcohol	O.CH.CH.CH.C.CH ₂ OH	+			
Gas, manufactured		as supplied commercially	+		
Gas, natural		techn. grade	+		
Geletin			+	+	+
Gin			+		
Glacial acetic acid (100% acetic acid)	CH ₃ COOH	techn. grade	+		-
Glauber's salt, aqueous	Na ₂ SO ₄ .10H ₂ O	any	+	+	+
Glucose, aqueous		any	+	+	+
Glycerin(e)	CH ₂ OH.CHOH.CH ₂ OH, Glycerol 1,2,3-Propanetriol	any	+	+	+
Glycine (Aminoacetic acid)	H ₂ NCH ₂ CO ₂ H		+	+	
Glycolic Acid, aqueous	HOCH ₂ CO ₂ H	up to 70%	+		
Heptane	CH ₃ (CH ₂) ₅ CH ₃		-	-	-
Hexafluorosilicic acid, aqueous	H ₂ SiF ₆	40%	+	+	
Hexane	CH ₃ (CH ₂) ₄ CH ₃		-	-	-
Hexanetriol	HO(CH ₂) ₄ CH(OH)CH ₂ OH	+	+	+	-
Honey			+	+	+
Hydrazine hydrate	NH ₂ .NH ₂ .H ₂ O		+		
Hydrobromic acid, aqueous	HBr	50%	+	+	
Hydrochloric acid, aqueous	HCl	any	+	+	
Hydrocyanic acid	HCN		+	+	

Classification: + = Resistant * = Likely to be resistant - = Not resistant □ = No data available

Substance	Formula	Concentration	Chemical Resistance of Vulcathene		
			20 °C	60 °C	80 °C
Hydrofluoric acid, aqueous	HF	85%	+		
Hydrogen	H ₂		+	+	
Hydrogen chloride gas, dry and moist			+	+	
Hydrogen peroxide, aqueous	H ₂ O ₂	10%	+	+	
Hydrogen peroxide, aqueous		30%	+		
Hydrogen sulphide, aqueous	H ₂ S	saturated	+	+	
Hydrogen sulphide, gaseous			+	+	
Hydroxylamine sulphated, aqueous	(H ₂ NOH) ₂ ·H ₂ SO ₄	12%	+	+	
Hypochlorous acid	HOCl		*	*	
Ink			+	+	
Iodine in potassium iodide solution		3% iodine	*	*	
Iodine tincture		as supplied commercially	*		
Isobutyl alcohol (Isobutanol)	C ₂ H ₅ CH(OH)CH ₃		+		
Isooctane	(CH ₃) ₂ CHCH ₂ C(CH ₃) ₃		-	-	
Isopropanol	(CH ₃) ₂ CHOH	techn. grade	+	+	+
Isopropyl ether	[(CH ₃) ₂ CH] ₂ O	techn. grade	-	-	-
i-Propanol (i-Propyl alcohol)	(CH ₃) ₂ CHOH		+	+	+
Jam			+	+	+
Lactic acid, aqueous	CH ₃ .CHOH.COOH	any	+	+	+
Lactose (milk sugar)			+	+	+
Lanolin	(wool fat)		+		
Latex			+	+	
Lead acetate, aqueous	(CH ₃ .COO) ₂ Pb.3H ₂ O	any	+	+	+
Lead tetraethyl			+		
Lime (See Note 5)	CaO		+	+	+
Lime water			+	+	+
Linseed oil		techn. grade	+	+	+
Lithium bromide			+	+	+
Magnesium carbonate	MgCO ₃ , MgCO ₃ .3H ₂ O, MgCO ₃ .5H ₂ O				
	Magnesite		+	+	+
Magnesium chloride, aqueous	MgCl ₂ , MgCl ₂ .6H ₂ O		+	+	+
Magnesium hydroxide (See Note 5)	Mg(OH) ₂		+	+	+
Magnesium iodide	Mg I ₂	any	+	+	+
Magnesium sulphate (Epsom salts), aqueous	MgSO ₄ , MgSO ₄ .H ₂ O, MgSO ₄ 7H ₂ O	up to 100%	+	+	+
Maleic acid, aqueous	HO ₂ CCH=CHCO ₂ H		+	+	+
Malic acid, aqueous	HO ₂ CCH ₂ CH(OH)CO ₂ H	50%	+	+	+
Manganese sulphate	MnSO ₄		+		
Margarine			+	+	
Mash		as supplied	+	+	
Mayonnaise			+		
Mercury	Hg		+	+	
Metal soaps			+	+	+
Methacrylic acid	H ₂ C=C(CH ₃)CO ₂ H		+	+	
Methanol	CH ₃ OH	techn. grade	+	+	
Methoxybutanol	CH ₃ O(CH ₂) ₄ OH		+		
Methoxybutyl acetate (®Butoxyl)	CH ₃ CO ₂ (CH ₂) ₄ OCH ₃		+		
Methylamine, aqueous	CH ₃ NH ₂	32%	+		
Methylene chloride (dichloromethane)	CH ₂ Cl ₂		-	-	-
Methylisobutyl ketone	(CH ₃) ₂ CH.Ch ₂ .COCH ₃	techn. grade	+		
Methyl acetate (Acetic acid methyl ester)	CH ₃ CO ₂ CH ₃	techn. grade	+	+	
Methyl alcohol	CH ₃ OH		+	+	

Classification: + = Resistant * = Likely to be resistant - = Not resistant □ = No data available

Substance	Formula	Concentration	Chemical Resistance of Vulcathene		
			20 °C	60 °C	80 °C
Methyl benzene	C ₆ H ₅ CH ₃		-	-	
Methyl bromide (Bromomethane), gaseous	CH ₃ Br	techn. grade	-	-	-
Methyl chloride (Chloromethane), gaseous	CH ₃ Cl	techn. grade	-	-	-
Methyl cyclohexane	C ₆ H ₁₁ CH ₃		-	-	-
Methyl ethyl ketone	C ₂ H ₅ .CO.CH ₃	techn. grade	+		
Methyl glycol			+	+	
4-Methyl pentanol-2	(CH ₃) ₂ CHCH ₂ CH(OH)CH ₃		+		
Methyl propyl ketone	CH ₃ COCH ₂ CH ₂ CH ₃		+		
Methyl salicylate (Salicylic acid methyl ester)	2-(HO)C ₆ H ₄ CO ₂ CH ₃		+		
Methyl sulphuric acid	CH ₃ OSO ₂ OH	50%	+	+	
Milk			+	+	+
Mineral water			+	+	+
Molasses			+	+	
Molasses wort			+	+	
Monochloroacetic acid	ClCH ₂ CO ₂ H		+	+	
Monochloroacetic acid ethyl ester	ClCH ₂ CO ₂ C ₂ H ₅		+	+	
Monochloroacetic acid methyl ester	ClCH ₂ CO ₂ CH ₃		+	+	
Morpholine	NHCH ₂ CH ₂ OCH ₂ CH ₂		+	+	
Mustard			+	+	+
Must		+	+	+	
Nail varnish remover	(see note 4)				
Nickel chloride	NiCl ₂ , NiCl ₂ . 6H ₂ O		+	+	+
Nickel nitrate	Ni(NO ₃) ₂ . 6H ₂ O		+	+	+
Nickel sulphate, aqueous	NiSO ₄ , NiSO ₄ . 6H ₂ O		+	+	+
Nicotinic acid	C ₆ H ₄ NCOOH	any	+	+	+
Nitric acid	HNO ₃	25%	+	-	-
2,2',2''-Nitrilotriethanol (Triethanolamine),	(HOCH ₂ CH ₂) ₃ N		+	+	
Nitrobenzene	C ₆ H ₅ NO ₂		+	+	
Nitrocellulose			+		
o-Nitrotoluene	CH ₃ . C ₆ H ₄ NO ₂		+	-	
Nonyl alcohol (nonanol)	CH ₃ (CH ₂) ₈ OH		+		
Nut oil			+		
Octyl cresol	CH ₃ (CH ₂) ₇ C ₆ H ₃ (CH ₂)OH	techn. grade		-	
Oleic acid	CH ₃ (CH ₂) ₇ CH:CH(CH ₂) ₇ COOH, 9-Octadecanoic acid		+	-	
Olive oil			+	+	+
Orange juice			+	+	+
Oxalic acid, aqueous	(COOH) ₂ .2H ₂ O	any	+	+	+
Oxygen	O ₂		+	+	
Ozone	O ₃	50 ppm	+	*	
Palmitic acid	CH ₃ . (CH ₂) ₁₄ . COOH		+	+	
Palmityl alcohol			+	+	
Palm nut oil			+	+	
Paraformaldehyde	(CH ₂ O) _n		+		
Peanut oil		techn. grade	+	+	
Pentanol	CH ₃ (CH ₂) ₄ OH		+		
Perchloric acid, aqueous	HClO ₄	20%	+	+	
Phenol (Carbolic acid)	C ₆ H ₅ OH		+	+	
Phenyl ethyl alcohol	C ₆ H ₅ CH ₂ CH ₂ OH		+		

Classification: + = Resistant * = Likely to be resistant - = Not resistant □ = No data available

Substance	Formula	Concentration	Chemical Resistance of Vulcathene		
			20 °C	60 °C	80 °C
Phenyl hydrazine hydrochloride	$C_6H_5NHNH_2 \cdot HCl$		+		
Phenyl sulphonate (Sodium dodecyl benzene sulphonate)	$C_{12}H_{25}C_6H_4SO_3Na$		+	+	
Phosgene, liquid		100%	-		
Phosphoric acid, aqueous	H_3PO_4	50%	+	+	+
Phosphoric acid, aqueous		80%...95%	+		
Phosphorus oxychloride	$POCl_3$		+		
Phosphorus pentoxide	P_2O_5	100%	+		
Phosphorus trichloride	PCl_3		+		
Phthalic acid, aqueous	$C_6H_4-1, 2-(CO_2H)_2$	50%	+	+	
Phthalic acid dibutyl ester (Dibutyl phthalate)	$C_6H_4(COOC_4H_9)_2$	techn. grade	+		
Picric acid, aqueous	$(O_2N)_3C_6H_2OH$	1%	+		
Pineapple juice			+	+	
Pine needle oil			+	+	
Polyglycols			+	+	
Potassium aluminium sulphate, aqueous	$KAl(SO_4)_2 \cdot 12H_2O$	any	+	+	+
Potassium bicarbonate, aqueous	$KHCO_2$	saturated	+	+	+
Potassium bicromate, aqueous	$K_2Cr_2O_7$	any	+	+	+
Potassium bisulphate, aqueous	$KHSO_4$	saturated	+	+	+
Potassium <i>meta</i> bisulphate, aqueous	$K_2S_2O_5$	saturated	+	+	+
Potassium borate, aqueous	KBO_2	1%	+	+	+
Potassium bromate, aqueous	$KBrO_3$	up to 10%	+	+	+
Potassium bromide, aqueous	KBr	any	+	+	+
Potassium carbonate	$K_2CO_3, K_2CO_3 \cdot 1\frac{1}{2}H_2O$, Potash	any	+	+	+
Potassium chlorate, aqueous	$KClO_3$	any	+	+	+
Potassium chloride, aqueous	KCl	any	+	+	+
Potassium chromate, aqueous	K_2CrO_4	40%	+	+	+
Potassium chromic sulphate (Chrome alum), aqueous	$KCr(SO_4)_2 \cdot 12H_2O$		+	+	+
Potassium cyanide, aqueous	KCN	any	+	+	+
Potassium dichromate, aqueous	$K_2Cr_2O_7$	saturated	+	+	+
Potassium ferricyanide, aqueous	$K_3Fe(CN)_6$	any	+	+	+
Potassium ferrocyanide, aqueous	$K_4Fe(CN)_6 \cdot 3H_2O$	saturated	+	+	+
Potassium fluoride, aqueous	KF	any	+	+	+
Potassium hexacyanoferrate, aqueous	$K_3Fe(CN)_6$ or $K_4Fe(CN)_6 \cdot 3H_2O$	any	+	+	+
Potassium hydrogen carbonate, aqueous	$KHCO_3$	saturated	+	+	+
Potassium hydrogen sulphate, aqueous	$KHSO_4$	saturated	+	+	+
Potassium hydrogen sulphate, aqueous	$K_2S_2O_5$	saturated	+	+	+
Potassium hydroxide, aqueous	KOH	any	+	+	+
Potassium iodide, aqueous	KI	any	+	+	+
Potassium nitrate, aqueous	KNO_3	any	+	+	+
Potassium perchlorate, aqueous	$KClO_4$	1%	+	+	
Potassium permanganate, aqueous	$KMnO_4$	up to 6%	+		
Potassium persulphate, aqueous	$K_2S_2O_8$	any	+	+	+
Potassium phosphate, aqueous	K_2PO_4	saturated	+	+	+
Potassium sulphate, aqueous	K_2SO_4	any	+	+	+
Potassium sulphide, aqueous	K_2S	saturated	+	+	
Potassium sulphite, aqueous	$K_2SO_3 \cdot 2H_2O$	saturated	+	+	+
Potassium thiosulphate, aqueous	$K_2S_2O_3 \cdot H_2O$	saturated	+	+	+
Propanol (Propyl alcohol)	$CH_3 CH_2 CHOH$	techn. grade	+	+	
i-Propanol (i-Propyl alcohol)	$(CH_3)_2CHOH$	techn. grade	+	+	
n-Propanol (n-Propyl alcohol)	$CH_3 CH_2 CH_2OH$	techn. grade	+	+	
Propargyl alcohol, aqueous	$HC \equiv CCH_2OH$	7%	+	+	

Classification: + = Resistant * = Likely to be resistant - = Not resistant □ = No data available

Substance	Formula	Concentration	Chemical Resistance of Vulcathene		
			20 °C	60 °C	80 °C
Propionic acid, aqueous	CH ₃ CH ₂ COOH	any	+	+	
Propylene dichloride	CH ₂ Cl CH Cl	100%	-	-	-
Propylene glycol	CH ₂ (CH ₂ OH) ₂ , Propane-1, 2-diol, CH ₃ CH(OH).CH ₂ OH, Propane-1,3-diol		+	+	+
Pyridine	C ₅ H ₅ N		*	*	
Quinine	C ₂₀ H ₂₄ N ₂ O ₂		+	+	
Rubber dispersions (latex)			+	+	
Salicylic acid	HOC ₆ H ₄ COOH		+	+	
Salt brines		saturated	+	+	
Sauerkraut (pickled cabbage)			+	+	+
Sea water			+	+	+
Silicic acid, aqueous	H ₂ SiO ₃	any	+	+	
Silicone emulsion		as supplied commercially			
Silicone oil		technical	+	+	+
Silver nitrate, aqueous	Ag NO ₃	any	+	+	+
Soap solution, aqueous		any	+	+	+
Soda (Sodium carbonate), aqueous		any	+	+	+
Sodium acetate, aqueous	CH ₃ .COONa, CH ₃ .COONa.3H ₂ O	any	+	+	+
Sodium aluminium sulphate	Na Al(SO ₄) ₂ 12H ₂ O		+	+	+
Sodium benzoate, aqueous	C ₆ H ₅ .COONa	any	+	+	+
Sodium bicarbonate, aqueous	NaHCO ₃	saturated	+	+	+
Sodium bisulphate, aqueous	NaHSO ₄ . H ₂ O	saturated	+	+	+
Sodium bisulphite, aqueous	Na ₂ S ₂ O ₅	saturated	+	+	+
Sodium borate	Na ₂ B ₄ O ₇		+	+	+
Sodium bromide	NaBr		+	+	+
Sodium carbonate, aqueous	Na ₂ CO ₃ , Na ₂ CO ₃ 10H ₂ O, Soda	any	+	+	+
Sodium chlorate, aqueous	NaClO ₃	saturated	+	+	
Sodium chloride, aqueous	NaCl	any	+	+	+
Sodium chlorite, aqueous	NaClO ₂	50%	+	+	
Sodium chromate	Na ₂ CrO ₄		+	+	+
Sodium cyanide	NaCN		+	+	+
Sodium dichromate	Na ₂ Cr ₂ O ₇ . 2H ₂ O		+	+	+
Sodium dodecylbenzenesulphonate	C ₁₂ H ₂₅ C ₆ H ₄ SO ₃ Na		+	+	+
Sodium ferricyanide	Na ₃ Fe(CN) ₆ H ₂ O		+	+	+
Sodium fluoride	NaF		+	+	+
Sodium hexacyanoferrate (III) (sodium ferrocyanide), aqueous	Na ₃ Fe(CN) ₆ . H ₂ O		+	+	+
Sodium hexacyanoferrate (II)	Na ₄ Fe(CN) ₆ . 3H ₂ O		+	+	+
Sodium hexametaphosphate, aqueous	(NaPO ₃) ₆	saturated	+	+	+
Sodium hydrogen carbonate, aqueous	Na HCO ₃		+	+	+
Sodium hydrogen sulphate, aqueous	NaHSO ₄	saturated	+	+	+
Sodium hydrogen sulphite, aqueous	NaHSO ₃	saturated	+	+	+
Sodium hydroxide, aqueous	NaOH	saturated	+	+	+
Sodium hydroxide, solid			+	+	
Sodium hypochlorite, aqueous with ≥5% active chlorine	NaOCl		-	-	-
Sodium nitrate, aqueous	NaNO ₃	any	+	+	+
Sodium perborate, aqueous	NaBO ₃ . 4H ₂ O				
Sodium phosphate(s)	Na ₂ HPO ₄ , NaPO ₄ . 12H ₂ O NaH ₂ PO ₄ , Na ₄ P ₂ O ₇ . 10H ₂ O	any	+	+	+
Sodium silicate, aqueous	A waterglass, NaO. x SiO ₂ where x = 3 to 5	any	+	+	+
Sodium sulphate, aqueous	Na ₂ SO ₄ .Na ₂ SO ₄ . 10H ₂ O, Glauber's salt	cold saturated	+	+	+
Sodium sulphide, aqueous		saturated	+	+	

Classification: + = Resistant * = Likely to be resistant - = Not resistant □ = No data available

Substance	Formula	Concentration	Chemical Resistance of Vulcathene		
			20 °C	60 °C	80 °C
Sodium sulphite, aqueous	Na ₂ SO ₃ , Na ₂ SO ₃ ·9H ₂ O	40%	+	+	+
Sodium tetraborate (Borax), aqueous	Na ₂ B ₄ O ₇ ·10H ₂ O, Borax	saturated	+	+	+
Sodium thiosulphate, aqueous	Na ₂ S ₂ O ₃ , Na ₂ S ₂ O ₃ ·5H ₂ O	saturated	+	+	+
Soft soap			+	+	+
Soya bean oil			+		
Spermaceti			+		
Stannic chloride, aqueous	SnCl ₄ , SnCl ₄ ·5H ₂ O	saturated	+	+	+
Stannous chloride, aqueous	SnCl ₂ , SnCl ₂ ·2H ₂ O	any	+	+	+
Starch, aqueous	C ₆ H ₁₀ O ₅	any	+	+	+
Starch gum		18%	+	+	+
Starch syrup			+	+	+
Stearic acid (See Note 2)	CH ₃ ·(CH ₂) ₁₆ ·COOH		+		
Styrene	C ₆ H ₅ CHCH ₂		+		
Succinic acid, aqueous	HOOC(CH ₂) ₂ COOH	50%	+	+	
Sugar syrup			+	+	+
Sulphuric acid, aqueous	H ₂ SO ₄	up to 50%	+	+	
Sulphuric acid, aqueous		80%	+	*	
Sulphuric acid, aqueous		98%	*	-	
Sulphur (See Note 2)	S ₈		+	+	+
Sulphurous acid	H ₂ SO ₃		+	+	
Sulphuryl chloride (sulphonyl chloride)	SO ₂ Cl ₂	techn. grade	-	-	-
Sulphur dioxide, aqueous	SO ₂	any	+	+	
Sulphur dioxide, gaseous			+	+	
Sulphur trioxide	SO ₃		-	-	-
Tallow		techn. grade	+	+	
Tannic acid (tannin), aqueous		10%	+	+	
Tanning extracts, vegetable		as supplied	+	*	
Tartaric acid, aqueous	(CHOH.COOH) ₂	any	+	+	
Tetrachloroethane	CHCl ₂ . CHCl ₂		-	-	-
Tetrachloromethane (Carbon tetrachloride)	CCl ₄	techn. grade	-	-	-
Tetrahydrofuran	CH ₂ (CH ₂). CH ₂ O □	techn. grade		-	-
Tetrahydronaphtalene	C ₆ H ₄ CH ₂ CH ₂ CH ₂ CH ₂ □	techn. grade	-	-	-
Thioglycolic acid	HSCH ₂ CO ₂ H		+	+	
Thionyl chloride	SOCl ₂		-	-	-
Thiophene	S(CH) ₃ CH □			-	-
Toluene	C ₆ H ₅ . CH ₃	techn. grade	-	-	-
Toluic acids (methyl benzoic acids)	CH ₃ . C ₆ H ₄ COOH	saturated	*		
Tomato juice			+	+	+
Tributyl phosphate	(C ₄ H ₉) ₃ PO ₄		+	+	
Trichloroacetaldehyde (chloral)	CCl ₃ CHO	techn. grade	+	+	
Trichloroacetic acid	CCl ₃ COOH	techn. grade	+		
Trichloroethylene	CHCl: CCl ₂	techn. grade	-	-	-
Tricesyl phosphate	(CH ₃ .C ₆ H ₄) ₃ PO ₄		+		
Triethanolamine	(HO CH ₂ CH ₂) ₃ N		+		
Triethanolamine (2,2'2"- Nitrotriethanol), aqueous		saturated	+		
Triethylene glycol	HOCH ₂ CH ₂ OCH ₂ CH ₂ OCH ₂ CH ₂ OH		+	+	

Classification: + = Resistant * = Likely to be resistant - = Not resistant □ = No data available

Substance	Formula	Concentration	Chemical Resistance of Vulcathene		
			20 °C	60 °C	80 °C
Trioctyl phosphate	$(C_8H_{17})_3PO_4$		+		
Trisodium phosphate	$Na_3PO_4 \cdot 12H_2O$		+	+	+
Tri-β-chloroethylphosphate	$(ClCH_2CH_2O)_3PO$		+		
Turpentine oil		techn. grade	-	-	-
®Tween 20 and 80			+	+	
Urea, aqueous	$NH_2 \cdot CO \cdot NH_2$	up to 33%	+	+	+
Uric acid (See Note 2)	$C_5H_4N_4O_3$		+		
Urine			+	+	
Vaseline		techn. grade	+	*	
Vinegar (wine vinegar)		as supplied commercially	+	+	
Vinylidene chloride (1,1 - Dichloroethylene)	CH_2CCl_2	techn. grade	-	-	-
Vinyl acetate	$CH_3COO \cdot CH \cdot CH_2$		+	*	
Viscose spinning solutions			+	+	
Vitamin C			+		
Vitamin preparations, dry (powder)			+		
Walnut oil			+		
Washing up liquids		usual	+	+	
Water, distilled	H_2O		+	+	+
Whey			+	+	+
Whisky			+		
White spirit		techn. grade	-	-	-
Wine		+	+		
Wine vinegar (table vinegar)		as supplied	+		
Xylene	$C_6H_4(CH_3)_2$		-	-	-
Yeast			+		
Zinc carbonate (See Note 5)	$ZnCO_3 \cdot 2ZnO \cdot 3H_2O$		+	+	+
Zinc chloride, aqueous	$ZnCl_2$	any	+	+	+
Zinc oxide (See Note 5)	ZnO		+	+	+
Zinc stearate	$[CH_3(CH_2)_{16}CO_2]_2Zn$		+	+	+
Zinc sulphate, aqueous	$ZnSO_4 \cdot 7H_2O$	any	+	+	+

Classification: **+** = Resistant ***** = Likely to be resistant **-** = Not resistant **□** = No data available

Durapipe UK Pipework Systems



- Air-Line Xtra**
- High performance thermoplastic pipework system for compressed air



- PLX**
- Purpose designed for safe fuel transfer
 - Suitable for pressure and vacuum applications
 - Resists fuel permeation



- Corzan**
- Solvent weld thermoplastic pipe system for aggressive substances
 - Designed specifically for use in highly corrosive conditions at temperatures up to 95°C
 - Valves range available



- Polypropylene**
- Conveys chemicals at temperatures up to 100°C
 - Excellent resistance to a wide range of substances
 - Available in larger diameters up to 500mm
 - Full range of valves



- SuperFLO ABS**
- Lightweight
 - Easy to install
 - Wide temperature range
 - Tough and durable
 - Corrosion resistant



- PVC-U**
- Versatile, multi-purpose solvent weld pipework system with an extensive range of valves and fittings
 - The established system for process and industrial handling of chemicals and water up to 60°C
 - Guardian dual contained PVC-U pipework system



- Guardian**
- Specialist dual contained pipework
 - Patented Centra-Lok™ system
 - Visual or automated leak detection system available



- Valves & Flow Control**
- Manual and actuated flow control solutions
 - For use with all Durapipe systems
 - Lightweight and easy to install

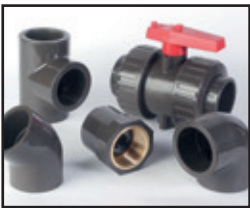

- HTA**
- Pipe system for hot & cold water
 - Limescale & corrosion resistant
 - Installed cost savings vs traditional materials



- Friaphon**
- Sound attenuated drainage system
 - Superb sound insulation with no lagging required
 - Ideal for hospitals, hotels, office suites and apartments

Durapipe UK reserves the right to modify the details in this publication as products and specifications are updated and improved. The content of this publication is for general information only and it is the user's responsibility to determine the suitability of any product for the purpose intended.

For further information on all Durapipe UK products and services contact our Customer Services Department as detailed below.

Customer Services

Tel: +44 (0)844 800 5509

Fax: +44 (0)1543 471682

Durapipe UK is a trade name of Glynwed Pipe Systems Ltd. Company Number 1698059.

Registered office:

Durapipe UK

Hyssop Close

Swaffield Park

Cannock

Staffordshire

WS11 7FU

United Kingdom

Tel: +44 (0)1543 471680

Fax: +44 (0)1543 471682

email: enquiries@durapipe.co.uk

web: www.durapipe.co.uk

Twitter: @DurapipeUK